



FARMTRAC 555DTc V

OPERATOR'S MANUAL

FARMTRAC TRACTORS EUROPE Sp. z o.o.

11-700 Mrągowo, ul. Przemysłowa 11, POLAND

www.farmtrac.pl

FARMTRAC 555DTc V

Operator's Manual

Publication: 221
Mrągowo 2024

Contents

Page

INTRODUCTION	4
1. GENERAL INFORMATION	7
1.1. Identification data.....	7
1.2. Safety precautions.....	9
1.3. Fire precautions.....	11
1.4. Warranty.....	12
1.5. Tractor delivery to purchaser.....	13
2. TECHNICAL SPECIFICATION.....	15
2.1. Engine.....	15
2.2. Electrical System.....	16
2.3. Transmission.....	16
2.4. Hydraulic lift system.....	17
2.5. Three-point linkage.....	17
2.6. Coupling devices.....	18
2.7. Steering system.....	18
2.8. Wheels & axles.....	18
2.9. Braking system.....	19
2.10. Tractor weight.....	20
2.11. Tractor dimensions.....	20
3. INSTRUMENT PANEL & CONTROL DEVICES.....	21
3.1. Instrument Panel.....	21
3.2. Control levers and pedals.....	28
3.3. Tractor cab.....	31
3.4. Air conditioning control panel.....	32
3.5. Operator's seat adjustments.....	33
4. OPERATION.....	35
4.1. Tractor running in.....	35
4.2. Starting and stopping the engine.....	35
4.3. Driving the tractor.....	37
4.3.1. Regeneration procedure of DPF filter.....	40
4.4 Power take-off (PTO).....	41
4.5. Tractor hydraulic system.....	42
4.5.1. Hydraulic lift system.....	43
4.5.2. External hydraulics control.....	45
4.6. Equipment attaching on three-point linkage.....	47
4.7. Attaching trailed machines and implements.....	49
4.8. Tractor weighing.....	49
4.9. Jacking Up Tractor.....	50
4.10. Engine bonnet opening.....	50
5. MAINTENANCE AND ADJUSTMENT.....	51
5.1. Periodic maintenance chart.....	51
5.2. Lubrication.....	53
5.2.1. Oils and liquids.....	53
5.2.2. Greases.....	53
5.2.3 . Reservoir filling.....	55

5.3. Engine.....	55
5.3.1. Engine lubrication system.....	55
5.3.2. Fuel system.....	56
5.3.3. Dry air cleaner.....	57
5.3.4. Cooling system.....	58
5.3.5. Engine cylinder head.....	Błąd! Nie zdefiniowano zakładki.
5.4. Electrical system.....	59
5.4.1 Alternator maintenance.....	59
5.4.2. Starter motor maintenance.....	60
5.4.3. Battery maintenance.....	60
5.4.4. Spot lights adjustment.....	60
5.4.5. Bulb and fuse - replacement.....	60
5.5. Hydrostatic steering system.....	62
5.6. Front axle.....	62
5.7. Wheels.....	63
5.7.1. Front wheel track adjustment.....	63
5.7.2. Front wheels toe-in.....	63
5.7.3. Rear wheel track adjustment.....	63
5.7.4. Tyres use & maintenance.....	64
5.8. Clutch.....	64
5.9. Transmission & rear axle maintenance.....	65
5.10. Three-point linkage.....	66
5.11. Cab and operator's seat.....	66
5.12. Braking system.....	67
5.12.1. Service break adjustment.....	67
5.12.2. Parking brake.....	67
5.13. Air braking system.....	68
5.14. Hydraulic lift.....	70
6. TRACTOR STORAGE.....	71

<p>Technical data regarding the construction, equipment, material, and external appearance are valid at the time of printing the instructions. The producer reserves the right to make changes.</p>
--

INTRODUCTION



This symbol warn of necessity of particularly careful due to possible risk for people and tractor damage.

Read this Manual carefully and familiarize yourself with all the controls before attempting to operate the tractor and observe the included rules.

Safety symbols

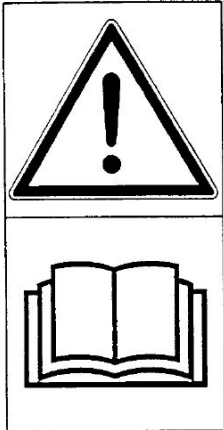

Read the operator's manual carefully.

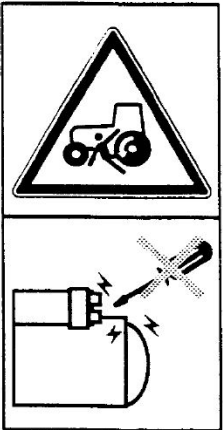

Always start the engine from the operator's seat.



Stay clear of draft link lifting range while operating rockshaft controls.

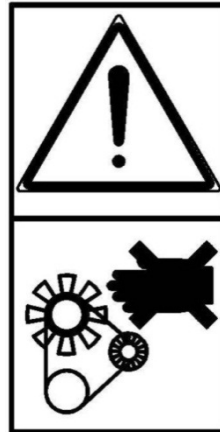

Keep your hands away from moving parts.

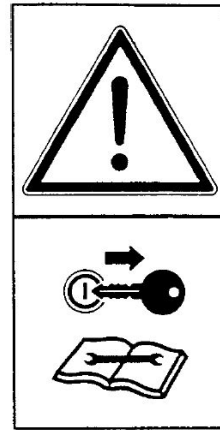

Stop the engine and remove the key before you start maintenance or repair operations



Wait until all machine components have completely stopped before touching them.



Do not open or remove safety shields while engine is running.



Stay clear of hot surfaces
- Burns to fingers or hands.



Stay clear of articulation area while engine is running.



Stay clear of tractor while engine is running.



Do not open or remove safety shields while engine is running.



Stay clear of tractor while on moving



Do not ride on platform or ladder.



Never reach into the crushing area.

Thank you for purchasing new Farmtrac tractor.

The operator's manual complies with the requirements set out in ISO 3600:1996 standard.

This Manual has been prepared to assist you in the correct procedure for running-in, driving and operating your new tractor and to assist you in the correct method of maintenance to keep it in peak condition.

Farmtrac series of tractors have been designed and build to give maximum performance, economy and ease of operation under a wide variety of operating conditions.

Prior to delivery, your tractor was carefully inspected, both at the factory and by your Authorized Dealer to ensure that it reaches you in optimum condition. To maintain this condition and ensure trouble-free operation, it is important that the routine services, as specified in this manual, are carried out at the recommended intervals.

The vehicle reference serial number should always be quoted to the Dealer whenever tractor requires service.

Read this manual carefully and keep it at a convenient place for future reference. This manual must be considered as an integral part of your tractor. If at any time you require service or advice concerning your tractor, do not hesitate to contact your Authorized Dealer.

He has trained personnel, genuine parts and the necessary equipment to carry out all your service requirements.

When replacement parts are required, it is important that only genuine or approved service parts be used. Extensive damage may occur as a result of fitment of parts of inferior quality.

All data given in this book is subject to production variations. Dimension and weights are approximate only and the illustrations do not necessarily show tractors in standard condition. Some of the equipment / accessories described in the text may also not be fitted on your tractor. For exact information about any particular tractor, please consult your Authorized Dealer.

1. GENERAL INFORMATION

1.1. Identification data.

- Tractor identification data is located:
 - on tractor identification plate, located on the left hand side on the rear wall of Cabin and affixed with rivets, (Fig. 1a),
The plate contains tractor serial number, engine serial number and year of manufacture, etc.
- The chassis (tractor) serial number is punctured on the clutch housing at the R.H. side of the tractor (Fig. 1b).
- The engine identification data:
 - on engine identification plate stuck on engine cylinder head (Fig. 1c).
- Cabin identification data - on identification plate on R.H. side rear pillar of cabin frame (inside cabin, Fig. 1e).
- Swinging Drawbar identification data - on identification plate on R.H. side of Drawbar (Fig. 1f).
- Tow Hook identification data - on identification plate on L.H. side of the Hook (Fig. 1h).

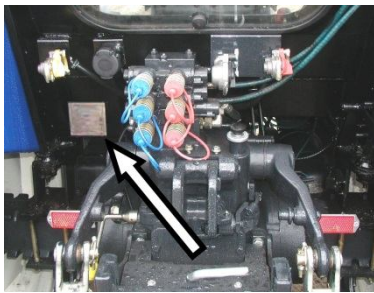

Fig. 1a

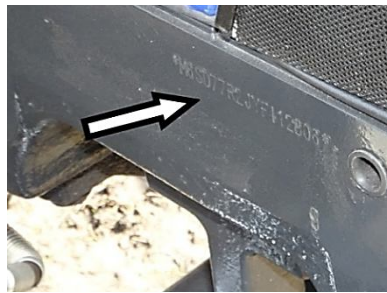

Fig. 1b

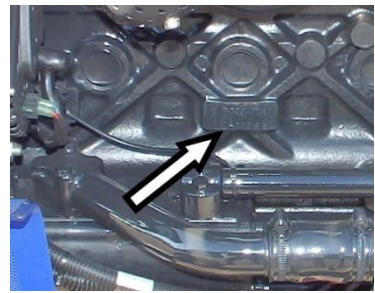

Fig. 1c



Fig. 1e

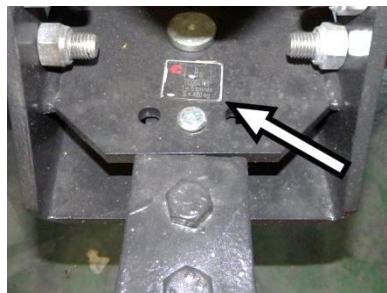

Fig. 1f

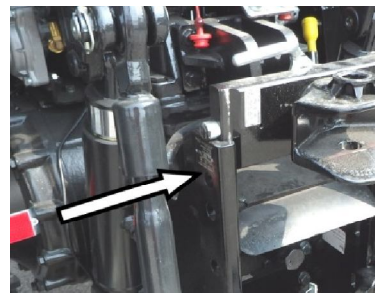

Fig. 1h

Noise Statement:

Exterior noise levels

While driving: dB (A)

At standstill: dB (A)

Noise level coming to the driver:

dB (A)

Vibration statement:

Vibrations felt on the operator's seat:

Load 60 Kg - $a_{wS}^* = m/s^2$

Load 98 Kg - $a_{wS}^* = m/s^2$

NOTE: Burning rate of cab interior material such as the seat covering, wall, floor and headliner coverings not exceeding 150 mm/min in accordance with ISO 3795:1989.

1.2. Safety precautions.

A careful operator is the best operator. Most accidents can be avoided by observing certain precautions to prevent the possibility of injury or damage. The following precautions should be taken to help prevent accidents. Read these carefully before operating your new Farmtrac tractor.



Important !

1. Read this Manual carefully and familiarize yourself with all the controls before attempting to operate the tractor. Working with unfamiliar equipment or lack of operating knowledge may lead to accidents.
2. Carrying of passenger is permissible only in approved passenger seat.
3. Use the foot steps and assist handles when getting on or off the tractor. It is recommended that you face the tractor when mounting or dismounting. Keep steps and platform clear of mud and debris.
4. Replace any warning sign on the tractor that becomes damaged or is painted over. Replace all missing, illegible or damaged safety decals.

Operating the tractor

1. Never start the engine while standing beside the tractor. Always sit on the tractor seat. Fasten seat belt and ensure that the Cab/ Roll Over Protective Structure (ROPS) (if fitted) is in place before starting the engine.
2. Apply the parking brake, place the PTO selection lever in the "Neutral" position, external hydraulics control lever in the "Neutral" position, the lift control levers in the down position and the transmission in neutral before starting the tractor.
3. Do not bypass the safety start switch. Consult your Dealer if your safety start control is not operating correctly.
4. Stop the engine, bring PTO selection lever in neutral position and apply the parking brake.
5. Do not engage the parking brake while the tractor is in motion.
6. Never get off the tractor while it is in motion.
7. Never park the tractor on a steep incline.
8. To provide maximum lateral stability, add liquid ballast to tyres and cast iron wheel weights and set front and rear wheels to maximum tread width commensurate with the operation being performed.
9. Do not tie ropes, chains, or cables to the axle or other parts of the chassis. Always hitch the load to the tractor's drawbar in the lowest possible position, except when pulling implements are specifically designed and properly attached to the three point hitch.
10. If the front tends to rise with heavy implements at the rear, install front end wafer weights.
11. Ensure that an implement coupled to the three-point linkage does not collide any part of the cab (applicable to tractors fitted with cab).
12. Ensure to stay clear from the area of the three-point linkage and of the pick-up hitch when controlling them.
13. Ensure to stay clear from the area between tractor and trailed vehicle.
14. Never leave equipment in raised position. Mounted machinery must be lowered to the ground before leaving the tractor.
15. If the engine or power steering ceases operating, stop the tractor immediately.
16. Always engage Position Control when attaching equipment, transporting equipment and when no equipment is attached. Be sure hydraulic couplers are properly mounted and will disconnect safely in case of accidental detachment of the implement.
17. Ensure any attached equipment or accessories are correctly installed, are approved for use with the tractor, do not overload the tractor and are operated and maintained in accordance with the instructions issued by the equipment or accessory manufacturer.
16. Remember that your tractor, if abused or incorrectly used, can be dangerous and become a hazard both to the operator and to bystanders. Do not overload or operate with attached equipment which is unsafe, not designed for the particular task or is poorly maintained.

**WARNING:**

Hearing protection must be applied when operating this tractor if a safety cab is not fitted.

Driving the tractor

1. Before you start driving always blow the horn to warn the people operating the machine attached to your tractor, bystanders and especially children.
2. Always drive the tractor with care and at speeds compatible with safety, especially when operating over rough ground, crossing ditches or slopes, or when turning, to avoid overturning the tractor.
3. Never allow the tractor to over-run when going downhill, particularly with trailed equipment attached. Keep the tractor in the same gear when going downhill as used when going uphill. Do not coast or free-wheel down hills. Use extreme caution while operating on steep slopes and use a low gear to maintain control with minimum braking.
4. Keep the brake pedals latched together at all times unless independent braking is required. This may be used to assist turning when traveling very slowly and on headlands.
5. Reduce speed before turning or applying the brakes. Brake both the wheels simultaneously when making an emergency stop.
6. Do not engage the differential lock when turning the tractor. When engaged, the lock will prevent the tractor taking the turn and may result in overturning of the tractor.
7. If the tractor drive wheels are stuck, shift to reverse gear and back out, to prevent from lifting the front wheels off the ground and possibly rolling the tractor over backwards.
8. Slow moving vehicles on highways are dangerous. Use a slow moving (SMV) sign in conjunction with headlights, tail lights and flashing warning lights.
9. Keep extreme caution and avoid hard application of the tractor brakes when towing heavy loads. Any towed vehicle whose total weight exceeds that of the tractor must be equipped with pneumatic brakes for safe operations.
10. Watch where you are going especially at row ends, on roads, around trees and any low hanging obstacle.
11. Avoid stability degradation when using heavy attached implements at height.
12. Dip the tractor lights when meeting a vehicle at night. Ensure the lights are adjusted to avoid blinding the driver of an oncoming vehicle.
13. Always check overhead clearance, especially when working in confined spaces.
14. Engage the clutch slowly when driving out of a ditch, gully or up a steep hillside. Disengage the clutch promptly if the front wheels rise off the ground.
15. Whenever possible avoid driving the tractor across slopes. Preferably drive up and down sloping fields. If it is necessary to work across slopes, proceed as follows:
 - use the widest wheel track setting compatible with the implement being used,
 - always turn uphill at the end of each run,
 - raise the implement to the height sufficient for making a turn only, or raise the implement using Position Control,
 - ensure that the rear tyre pressures are equal,
 - reduce the speed to a minimum on headlands,
 - when using a reversible plough, start at the top of the slope to reduce the tractor inclination angle by making the top wheels run in the furrow.
16. Service Tires Safely.

Explosive separation of a tire and rim parts can cause serious injury or death. Do not attempt to mount a tire unless you have the proper equipment and experience to perform the job. Always maintain the correct tire pressure. Do not inflate the tires above the recommended pressure. Never weld or heat a wheel and tire assembly. The heat can cause an increase in air pressure resulting in a tire explosion.

Operating the PTO

1. Ensure the PTO guard is always installed and replace the PTO shaft cap when the PTO is not being used.
2. Disengage the independent PTO clutch prior the selection of PTO. Before stopping the engine, bring the PTO selection lever in neutral position and wait for the PTO shaft to stop turning before getting off the tractor to connect or disconnect PTO driven equipment.
3. Apply the parking brake and block the rear wheels, front and rear, when operating stationary PTO driven equipment.
4. To avoid injury, never clean, unclog, adjust or service PTO driven equipment while PTO is engaged.
5. Never wear loose clothing when operating the PTO or when near equipment that is rotating.
6. Before operating implements, study the implement manufacturer's handbook. Certain implements require special operating techniques.

Servicing the tractor

1. Keep the tractor and equipment, particularly brakes and steering, maintained in a reliable and satisfactory condition to ensure your safety and comply with legal requirements.
2. Stop the engine and disconnect battery terminals before performing any service on the tractor.
3. To prevent fire or explosion, keep open flames away from the battery. To prevent sparks which could cause explosion, use jumper cables according to instructions.
4. The fuel oil in the injection system and fluid in the hydraulic system are under high pressure and can penetrate the skin. Unqualified and unauthorized persons should not remove or attempt to adjust a pump, injector, nozzle or any other part of the fuel infection system. This also may be unlawful under certain circumstances. Failure to follow these instructions can result in serious injury.
5. Do not use your hand to check for leaks. Use a piece of cardboard or paper to search for leaks.
6. Stop the engine and relieve pressure before connecting or disconnecting hydraulic or fuel lines.
7. Tighten all connections before starting the engine or pressurizing lines.
8. If fluid is injected into the skin, obtain medical attention immediately.
9. The cooling system is operated under pressure which is controlled by the radiator cap. It is dangerous to remove the cap while the system is hot. Allow the engine to cool, then turn the cap slowly to the first stop and allow the pressure to escape before removing the cap entirely.
10. Continuous long term contact with used engine oil may cause skin cancer. Avoid prolonged contact with used engine oil. Wash skin promptly with soap and water.
11. Do not run the tractor engine in a closed building without adequate ventilation as exhaust fumes may suffocate you.
12. Do not modify, or alter, or permit anyone else to modify, or alter the tractor, or any of its components, or any tractor function without first consulting your Authorized Dealer.
13. Tractor wheels are heavy. Handle them with care and ensure that, when stored, they cannot topple and cause injury.
14. Discard the used lubricating oils and filter canisters in accordance with local regulations.

1.3. Fire precautions.

1. Under no circumstances should gasoline, alcohol or blended fuels be added to fuel oil. These combinations can create an increased fire or explosive hazard. In a closed container, such as a fuel tank, these blends are more explosive than pure gasoline. **Do not use these blends.**
2. Never remove the fuel cap or refuel with the engine running or hot.
3. Do not smoke or allow an open flame near the fuel tank or while re-fuelling the tractor. Wait for the engine to cool before re-fuelling.
4. Maintain control on the fuel filler pipe nozzle when filling the tank.
5. Do not fill the fuel tank to its capacity. Allow room for expansion.
6. Wipe up spilled fuel immediately.
7. Always tighten the fuel tank cap securely.
8. If the original fuel tank cap is lost, replace it with an approved cap. A non-approved cap may not be safe.
9. Keep equipment clean and properly maintained.

10. Do not drive equipment near open fires.
11. Should the fuel catch fire, extinguish fire covering it tightly with asbestos blanket, canvas sheet or rags, or else by pouring sand or soil over the fire. Never use water to extinguish burning fuel or lubricants as this makes the fire to spread even faster. A fire extinguisher should be carried with the tractor.
12. Precautions should be taken to ensure that stored fuel is kept free of dirt, water, etc.
13. Fuel should be stored in black iron tanks, not galvanized tanks, as the galvanized coating will react with the fuel and form compounds that will contaminate the injection pump and injectors.
14. Bulk storage tanks should be installed away from direct sunlight and angled slightly so that the outlet pipe is at the higher end. In this way sediment in the tank will settle away from the outlet pipe.
15. To facilitate moisture and sediment removal, a drain plug should be provided at the lowest point (at the opposite end to the outlet pipe). If there is no filter on the outlet pipe, then a funnel with a fine mesh screen should be used when filling the tractor fuel tank.

	<p>WARNING: The fuel oil in the injecting system is pressurized and can penetrate human skin with fatal results. Adjustment of fuel injection equipment should not be carried out by unqualified persons.</p>
---	--

Safety frame or roll bar (where fitted)

Your tractor is equipped with a CAB/ROPS which must be maintained in a serviceable condition. Be careful when driving through doorways or working in confined spaces with low headroom.

Do not:

- I) Modify, drill, weld or alter the CAB/ROPS in any way. Doing so could render you liable to legal prosecution in some counties.
- II) Attempt to straighten or weld any part of the CAB/ROPS or retaining brackets which have suffered damage. By doing so you may weaken the structure and endanger you safety.
- III) Secure any parts on the CAB/ROPS or attach it with other than special high tensile bolts and nuts specified.
- IV) Attach chains or ropes to the CAB/ROPS for pulling purposes.
- V) Take unnecessary risks even though your CAB/ROPS affords you the maximum protection possible.

1.4. Warranty.

FARMTRAC TRACTORS EUROPE, when selling tractors to its Authorized Dealers, gives a warranty which, subject to certain conditions guarantees that tractors are free from defects in material and workmanship.

Each FARMTRAC TRACTORS EUROPE Authorized Dealer is required to give a similar warranty for the benefit of the first retail purchaser of a new tractor supplied by FARMTRAC TRACTORS EUROPE.

Under the terms of warranty the purchaser is entitled to a specified, service inspections and repairs including parts replacement, if the manufacturer is responsible for the defect.

NOTE:	FARMTRAC TRACTORS EUROPE will not accept responsibility for any claim resulting from the fitment of non-approved parts or attachments, or unauthorized modification or alteration.
--------------	--

NOTE:	Repairs of parts protected with seals can be carried out by an Authorized Dealer only. Arbitrary removal or breaking of the seal may lead to warranty invalidation.
--------------	---

1.5. Tractor delivery to purchaser.

The Dealer is required to carry out certain activities when supplying a new Farmtrac tractor.

This consist of a full pre-delivery inspection to ensure that the tractor supplied is ready for immediate use and full instructions in the basic principles of operation and maintenance of the tractor. These instructions will cover instruments and controls, routine maintenance and safety precautions. All persons who will be concerned with the operation and maintenance of the machine should be present for these instructions.

The following check list items should be covered by the Dealer during the tractor handing over:

- all safety points and decals on the tractor and in the Operator's Manual,
- location and significance of tractor and engine serial numbers,
- use of all instruments and controls,
- running in procedure,
- engine starting and stopping procedure, when hot and cold,
- driving the tractor, starting and stopping,
- gear selection for the particular operation to be performed,
- towing of the tractor,
- use and adjustment of clutches,
- brakes, latched and unlatched, method of adjustment,
- differential lock, its engagement, disengagement and adjustment,
- use of power take-off,
- how to use the hydraulic lift system, attach/detach implements and use of stabilizers.
- use of external hydraulics,
- four-wheel drive, its engagement and disengagement,
- the method of making the wheel track adjustments, front wheel alignment and use of correct tyre pressure,
- cooling system, frost precautions and fan belt adjustment.
- maintenance of the engine air cleaner,
- fuel system and how to remove the air,
- electrical system maintenance,
- bolts and nuts fastening,
- grease points,
- oil changes and location of drain plugs, filler plugs and dipsticks,
- filter replacement and cleaning,
- transport and storage of fuel,
- warranty entitlement and the services due during the warranty period.

Pre-delivery inspection

The following items must be checked, and where necessary, corrected by the Dealer before delivery:

1. Verify serial numbers of the tractor and engine.
2. Assemble parts removed for transport.
3. Check the tractor against its specification.
4. Examine the condition of factory seals.
5. Remove water and impurities from water trap and bleed the fuel system.
6. Check the liquid level in the cooling system and in screen washer system.
7. Check the oil level in all system.
8. Check the battery electrolyte level and electrolyte concentration.
9. Lubricate all grease points, if necessary.
10. Check for tightness and locking all external nuts, bolts, screw, plugs, connections, and clamping bands (special attention should be paid to air intake and cooling system hose and pipe connections).
11. Ensure that pipes, hoses and wiring are not fouling exhaust system or sharp edges.
12. Check the fan and air compressor (if fitted) V-belt tension.
13. Check clutch pedal free travel.
14. Check tyre pressure.
15. Check front wheel alignment and hub bearings for play.
16. Check the safety start switch function.
17. Check the headlight setting.
18. Road test the tractor checking all instruments, controls and services for correct function.
19. After road test, check for leaks.

2. TECHNICAL SPECIFICATION.

Specification / Tractor model	FT 555 DTC V
-------------------------------	--------------

2.1. Engine.

Engine model	NRE-v-3
Engine type	four stroke, water-cooled, direct injection diesel, exhaust after-treatment system
Number of cylinders	3, vertical, in-line
Firing order	1 - 2 - 3
Bore / stroke	98 / 122 [mm]
Capacity	2760 [cm ³]
Compression ratio	17,5:1
Engine rated power	36,53 kW
Engine rated speed	2000 [rpm]
Maximum engine torque	200 [Nm] at 1000-1200 rpm
Low idle speed, rpm	700 - 800 [rpm]

Fuel System

Max. no load speed	2175+5/-25 rpm
Fuel Feed pump	Electrical
Fuel filter	Separator and filter, between fuel feed pump and F.I.P.
Recommended fuel:	Diesel fuel
• summer	B w/g PN-EN 590+A1:2017
• interim period	D w/g PN-EN 590+A1:2017
• winter	F w/g PN-EN 590+A1:2017
Fuel tank capacity	80 [dm ³]

Lubrication System

Type	Full flow, force feed and splash
Pump type	Eccentric
Oil filter type	Spin on, throw away type
Lubricating system capacity	6,0 dm ³
Recommended oil	API CK-4

Cooling System

Type	Pressurised recirculation, by pass with radiator, fan, thermostat
Cooling system capacity, litres	12,9 dm ³
Recommended coolant	see coolant specification

Air cleaner

Type	dry type, two-stage, in front of radiator
------	---

2.2. Electrical System.

Type	single line, 12V with negative to earth
Alternator	12V/55A
Battery	12V, 120Ah, 900A
Starter motor	12V/2 kW
Starting aid	glow plug
Electrical socket	Seven pin socket

2.3. Transmission.

Clutch.

Type	friction type, dry, two-disc clutch with independent control of PTO clutch
Pedal free travel (Transmission clutch)	32 ÷ 38 mm
Actuation	Transmission clutch – foot pedal, PTO clutch – hydraulic

Gearbox with range lever

Number of gears in gearbox	4 + 4R
Number of reduction gears	2
Total number of forward/reverse gears	8 F; 8 R
Gearbox control	manual by means of four levers
Oil capacity	See rear axle

Rear Axle

Differential – differential lock	mechanical
Final reduction gears - type	epicyclical
Recommended oil	API GL-4 10W-40
Oil capacity: gear box, rear axle, hydraulic system	30,0 dm ³
Other	- safety start

Theoretical tractor ground speeds in km/h at engine rated speed for 13.6-28 tyre size

Table 1.

Speed range	Gear No.	Total ratio
L	1L	175,71
	2L	120,00
	3L	81,82
	4L	56,84
H	1H	47,92
	2H	32,73
	3H	22,31
	4H	15,5
L	1RL	176,09
	2RL	120,26
	3RL	81,99
	4RL	56,96
H	1RH	48,03
	2RH	32,80
	3RH	22,36
	4RH	15,54

Calculated maximum tractor speed in top gear: 29,83 km/h

Theoretical tractor ground speeds in km/h at engine rated speed – 2000 rpm

Gear No	Tire size	
	14,9-28	
	Forward	Reverse
1L	2.63	2.63
2L	3.85	3.84
3L	5.65	5.64
4L	8.14	8.12
1H	9.65	9.63
2H	14.13	14.10
3H	20.72	20.68
4H	29.82	29.76

Front axle

Axle housing oil capacity	5,9 dm ³
Recommended oil	API GL-4 80W-90

Power Take-Off - PTO

Type	independent and ground
PTO clutch control	mechanical
PTO shaft end	Type 1 per PN-86/R-36101 - 6 (ISO 500)
Independent PTO shaft speed	540 rpm at 1728 rpm 540E at 1251 rpm
Engine – PTO ratio	at 540 rpm. - 3,2 at 540E - 2,32
Rotation	rightwards, from tractor end

2.4. Hydraulic lift system.

Type	piston type with position & draft control
Hydraulic pump type	gear
Hydraulic pump capacity- at 2200 rpm	32,4 + 19,8 dm ³ / min
Nominal Pressure	185±5 MPa
Number of quick couplings for external hydraulics	4
Quick couplings type	ISO 12.5
Oil filter	on the suction side of the pump
External hydraulics	control of three double acting or six single acting ram cylinders

2.5. Three-point linkage.

Type	lever type, accordant to PN-88/R-36110
Category	2 per ISO 730-1:1994
Lifting capacity at the ends of lower links in horizontal position	1500 kg

2.6. Coupling devices.

Type			Swinging drawbar	Tow hook
Manufacturer's type designation:			FCSS50	FCT50
Maximum horizontal load:			5000 kg	5000 kg
Towable mass:			5 T	5 T
Maximum permissible vertical load on the coupling point:			500 kg	500 kg
Position of coupling point	height above ground	min.	270 mm	350 mm
		max.	330 mm	560 mm
	distance from vertical plane through the axis of the rear axle	min.	530 mm	380 mm
		max.	630 mm	380 mm

2.7. Steering system.

Type	hydrostatic
Oil capacity	2,5 l
Recommended oil	Hipol ATF-2D
Number of steering wheel revolutions from lock to lock	1,5 right/left

2.8. Wheels & axles.

Front axle type	rigid, swivel pin mounted, driven
Rear wheels: <ul style="list-style-type: none"> • Tire size - standard • Wheel track • Recommended inflation pressures: 	14,9 - 28 6 PR 1340 - 1550 mm 110 - 124 kPa 193 - 207 kPa
Front wheels: <ul style="list-style-type: none"> • Tire size - standard • Wheel track • Recommended inflation pressures: 	280/70 R18 PR 1200 – 1550 mm 179 - 193 kPa 193 - 207 kPa

2.9. Braking system.

Service brake:	
• Type	wet, disc type
• Control	hydraulic, foot control, with possibility of left & right wheel independent braking
• Acting on	rear axle 2 wheels
Emergency brake:	function fulfilled by parking and service brake
Parking brake	
• Type	wet, disc type
• Control	mechanical, hand lever operated
• Acting on	rear axle wheels
• Trailer air braking system.	over-pressured, single-line or triple-line type
- Air reservoir capacity	15 dm ³
Standard air pressure	810 ^{±20} kPa
Pressure drop at warning lamp on	450 ^{±50} kPa

2.10. Tractor weight.

Weight of tractor in running order:	2490 kg
Weight distribution on axle:	
• front	1050 kg
• rear	1440 kg
Maximum permissible weight of tractor:	3690 kg
Weight distribution on axle:	
• front	1290 kg
• rear	2400 kg
Maximum permissible load on axle:	
• front	1370 kg
• rear	1530 kg
Technically permissible tractor towable mass:	
• Unbraked	2000 kg
• Inertia braked	2000 kg
• Hydraulic or pneumatic braked	5000 kg
Total technically permissible mass of the combination of tractor with a towed vehicle:	
• Unbraked	5690 kg
• Inertia braked	5690 kg
• Hydraulic or pneumatic braked	8690 kg
Ballast weights	
• Front axle	$4 \times 22 + 1 \times 40 + 1 \times 80 = 208 \text{ kg}$

2.11. Tractor dimensions.

Overall length	3386 -3595 mm
Overall width	1700 - 1900 mm
Overall height	2260 - 2460 mm
Wheelbase	1885 mm
Ground clearance	400 mm
Minimum turning circle without independent braking to the right/left	6400±10 mm
Minimum turning angle of steering wheels to the right/left	51+/-1°

3. INSTRUMENT PANEL & CONTROL DEVICES.

3.1. Instrument Panel.

The following text describes the various gauges, switches, warning lights and control levers situated on the instrument panel, or close to it (Fig. 3.1).

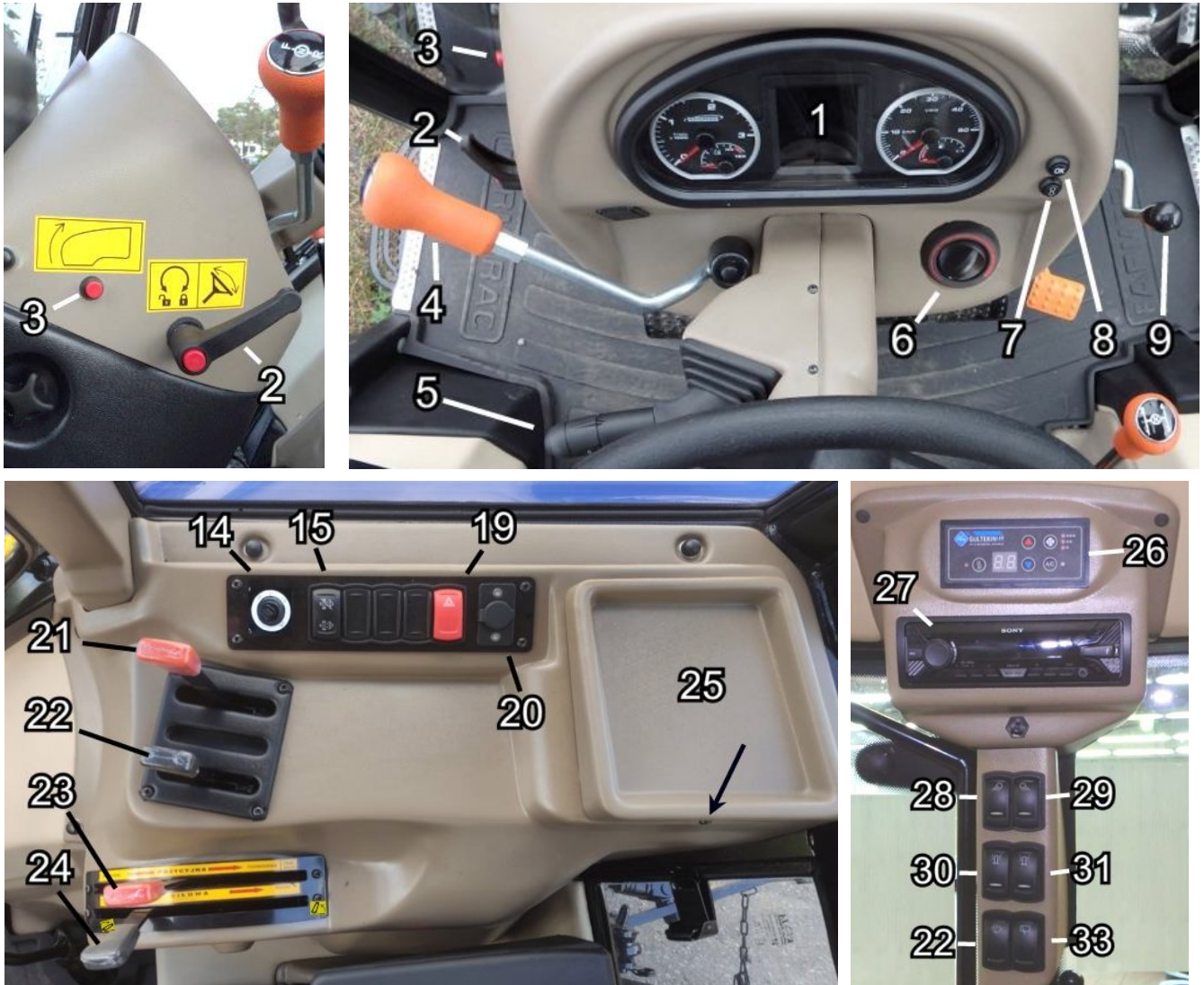

Fig. 3.1 Instrument panel referring KOJA cabin, see description below.

Description of elements shown on Fig. 3.1

1. Instrument panel

Description on following pages.

2. Lever for steering column inclination angle adjustment

In order to adjust steering column inclination angle turn the adjustment lever clockwise and set the steering wheel is in desired position. After so, turn the lever counter clockwise to lock the steering column movement.

3. Ventilation switch

The blower operates only if the ignition switch is in AUXILLIARY position. The switch controls air blowing level through air diffusers.

4. Shuttle lever (described in chapter 3.2) orange

5. Combined switch

Steering column combined switch is operational when the ignition is on:

- Downward: left direction indicator,
- Upwards: right direction indicator,
- Push-in: horn,
- First step by rotation: parking lights,
- Second step by rotation: dimmed beams,
- Push backward: long beams.

6. Knob for coolant flow control for cabin heater

7. Display operating button

Used to adjust the backlight brightness

8. Display operating button

Used to set the clock and operating hour daily counter. Pressing the button changes the illuminated function. After holding the button illumination starts flashing. The next press allows you to change the clock or reset the daily hours counter. Holding key approves the change.

9. Hand throttle orange

This lever is used to selected engine speed. Pull the lever backwards to progressively increase the engine speed. Push the throttle lever forwards to decrease the engine speed.

When traveling on the road, the foot throttle should be used, and the hand throttle lever should be brought to the closed position.

14. Ignition switch

Four positions Ignition switch. By turning the key clockwise, the positions are:

0. OFF

1. Through 30° - Switches on electrical consumers when the engine is not running.

2. Key turned for next 30° - In this position the glow plugs are energized for cold engine starting.

3. Key turned for next 30° - In this position starter motor is turned on. When the key is released, the key returns automatically to the 2 position.

By turning the key back to position 0 the engine is switched off.

15. DPF regeneration control switch



Pressing the key for at least 2 seconds on symbol  forces the DPF active regeneration.

The need of active regeneration is indicated with high degree of soot accumulation in DPF filter indicator light (19 - Fig. 3.2)

Pressing the key for at least 2 seconds on symbol  during an active DPF regeneration process postpone regeneration process.

WARNING:



Flashing indicator light  (24 - Fig. 3.2) with indicator light on  (19 - Fig. 3.2) showing the active regeneration must be completed to avoid accelerated wear of DPF filter.

19. Hazard warning switch red

By pressing on the switch the hazard warning lights are turned on. All direction indicators flash simultaneously. Hazard warning indicators operate in any position of the ignition switch.

20. 12 Volt socket

21, 22. External hydraulics control levers

Controls oil flow in external hydraulic valves (described in chapter 4.5.2)

23, 24. Hydraulic lift control levers

These levers are used to control the action of the tractor three-point linkage. External lever is Position Control lever and the internal is Draft Control lever. For detailed operating instructions, see section – “OPERATION”

25. Fuse box cover

To gain access remove screw shown with an arrow

26. Air conditioning control panel

Tractors are optionally equipped with an air-conditioned cabin.

Air conditioning ensures optimal temperature and low humidity in the cabin.

For a detailed description, see section 3.3

27. Radio player

28. Roof LH flasher lamp switch

29. Roof RH flasher lamp switch

30. Front roof work lamps switch

31. Rear roof work lamps switch

32. Front windscreen wiper switch

The switch has 3 position:

0 – Wiper and washer off

1 – Wiper on

2 – Wiper and washer on









33. Rear window wiper switch















Instrument panel – indicators



Fig. 3.2. Instrument panel - indicators

Instrument panel - indicator lights description (1 - Fig. 3.1)

1.		Front work lights indicator light yellow Front work lights indicator light illuminates when the front work lights are switched on.
2.		Rear work lights yellow Rear work lights indicator light illuminates when the rear work lights are switched on.
3.		Trailer 2 turn indicators light green Trailer turn indicators indicator light flashes simultaneously with the direction indicators when they are turned on. It also flashes when the hazard warning indicators are turned on. This indicator light operates only if the trailer is connected to the tractor.
4.		Trailer 1 turn indicators light green Trailer turn indicators indicator light flashes simultaneously with the direction indicators when they are turned on. It also flashes when the hazard warning indicators are turned on. This indicator light operates only if the trailer is connected to the tractor.
5.		Main beam indicator light blue This light illuminates when the headlights are switched to main beam.
6.		Dipped beam indicator light green Dipped beam indicator light illuminates as soon as the dipped beam headlights are switched on.
7.		Turn indicators indicator light green Turn indicators indicator light flashes simultaneously with the direction indicators when they are turned on. It also flashes when the hazard warning indicators are turned on.
8.		Engine oil pressure warning light red Engine oil pressure warning light illuminates if the pressure in the engine lubrication system is too low. If the light illuminates during engine operation, immediately stop the engine and check the engine oil level. It must shut down when the engine is started.
9.		Battery charging warning light red It must shut down when the engine is running. Alternator warning light illuminates if there is a fault in the battery charging system. When possible investigate the cause of the fault, otherwise the battery will be fully discharged.

10.		Air filter clogged indicator light yellow Air filter clogged warning light illuminates if the air pressure drop when passing through the filter is too high. It is necessary to check the engine air filter and replace the filter cartridges if necessary.
11.	-	Not applicable
12.		Air pressure warning light red It lights if the air pressure in trailer brake system falls too low.
13.		Parking brake warning light red It lights when parking brake is applied.
14.		Not applicable
15.		Steering system malfunction warning light red Lights in case of hydrostatic steering system failure
16.		Rotation beacon lamp indicator light yellow This illuminates when rotation beacon lamp on the roof is on
17.		Active regeneration process interruption indicator light yellow Lights when active regeneration of the DPF has been interrupted.
18.		Exhaust system high temperature indicator light yellow Lights during active regeneration process of DPF filter indicating the high temperature of exhaust system. During DPF filter active regeneration fuel consumption increases
19.		High degree of soot accumulation in DPF filter indicator light yellow Lights when soot loading in DPF exceeds level that active regeneration is needed
20.		Differential lock indicator light yellow Differential lock indicator light illuminates if the rear differential lock is applied. Never use the differential lock on dry road and during sharp cornering. Differential lock must be switched off as soon as possible.
21.		PTO clutch indicator light yellow PTO clutch light illuminates when PTO clutch is engaged (PTO drive is not transferred). The PTO clutch switch can be used for short time (PTO drive disengaged). Keeping PTO clutch disengaged for longer may cause the clutch failure).
22.		Engine pre-heat indicator light yellow Engine pre-heat indicator light illuminates when the start switch is in PRE-HEAT position and the glow plugs are activated.
23.		Four wheel drive indicator light yellow Four wheel indicator light illuminates if the four wheel drive is engaged.
24.		The warning lamp improper operation of the engine yellow If illuminates while engine is running, find the cause of system malfunction or contact your authorized service centre.
25.		Engine failure warning light red When the engine is started, the light should go off. If during engine operation light is on, stop engine immediately and contact an authorized service centre.
26.		Fuel level indicator light yellow Fuel level light illuminates if there is approximately 17 litres of fuel left in the reservoir.

Description of instrument panel indicators (1 - Fig. 3.2)

27. Engine revolutions counter

Indicates current engine rpm.

28. Water temperature gauge

Indicates temperature of engine coolant.

When engine is running the temperature should be within 75÷ 90°C (green area on indicator).

29. Driving speed indicator

30. Fuel gauge

Indicates the current fuel level. Red area shows 0÷17 litres of fuel in the tank.

31. LCD central display

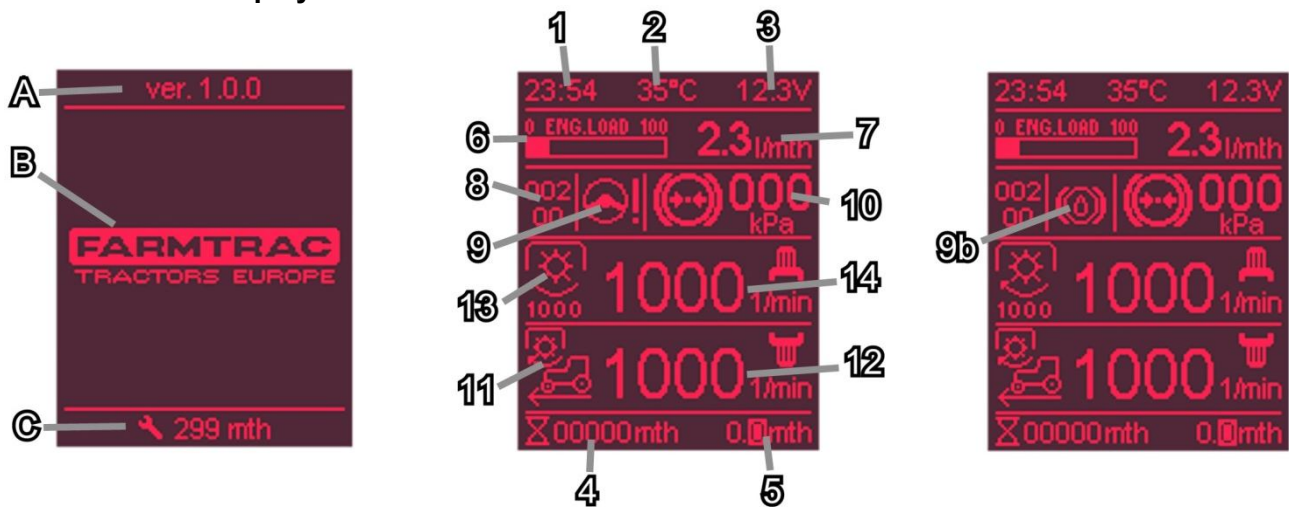

Fig. 3.3.1 LCD central display
Start screen

Fig. 3.3.2 LCD central display
Work screen

LCD central display description (31 - Fig. 3.2)

Start screen area (Fig. 3.3.1)

After ignition on, a start screen is displayed for a short time showing:

A. Software version.

B. Company logo.

C. Hours of operation number remaining for the technical inspection.

After 30 mth, then 300 mth, the "SERVICE" message is displayed in the field C.

The message is deleted in service mode after the inspection.

Work screen area (Fig. 3.3.2)

General information area

1. Clock

Indicates current time.

2. Thermometer

Indicates outside temperature

3. Voltmeter

Indicates the current battery voltage

Working hours display area

After 30 mth, then 300 mth, the "SERVICE" message is displayed in the field 4 and 5.
The message is deleted in service mode after the relevant inspection.

4. Hour meter

Indicates total operating time of the tractor

5. Daily Hour Meter

Indicates number of operating hours from last reset

Tractor operation economics area

6. Indicator of engine current load

Indicates the current engine load in the range of 0 to 100%

7. Fuel consumption

Indicates the current fuel consumption

Additional display area

8. DTC - Diagnostic trouble codes.

Indicates the code identifying the type of fault.

Some codes may identify an event and may not occur after the engine has been restarted.

9. Steering system failure indicator

Indicates the failure of the hydrostatic steering system.

9b. Brake fluid low level (serves as a warning lamp)

Indicates brake fluid low level in the container

10. Pneumatic system pressure indicator

Indicates current pressure in tractor pneumatic system in kPa

Rear PTO display area

11. PTO drive gear ratio (serves as a warning lamp)

Indicates current PTO drive ratio. If PTO switch is in the neutral position, the field is blank

12. PTO speed indicator

Indicates PTO shaft current speed in rev/min. If PTO drive is in neutral position, the field is blank

Front PTO display area (optional)

13. PTO drive gear ratio (serves as a warning lamp)

Indicates current PTO drive ratio. If PTO switch is in the neutral position, the field is blank

14. PTO speed indicator

Indicates PTO shaft current speed in rev/min. If PTO drive is in neutral position, the field is blank

NOTE: The front drive should only be used when operating in field conditions. Do not operate the tractor in four wheel drive on the road (with the exception of uphill driving) as this may lead to premature wear of front tires and excessive fuel consumption.
Before engage / disengage front drive, push clutch pedal.

WARNING:



Disengage PTO clutch only for time needed to switch the control levers position!
The PTO clutch switch can be used for short time (PTO drive disengaged – control lamp on).

3.2. Control levers and pedals.

Control levers and pedals are shown at Fig. 3.4.

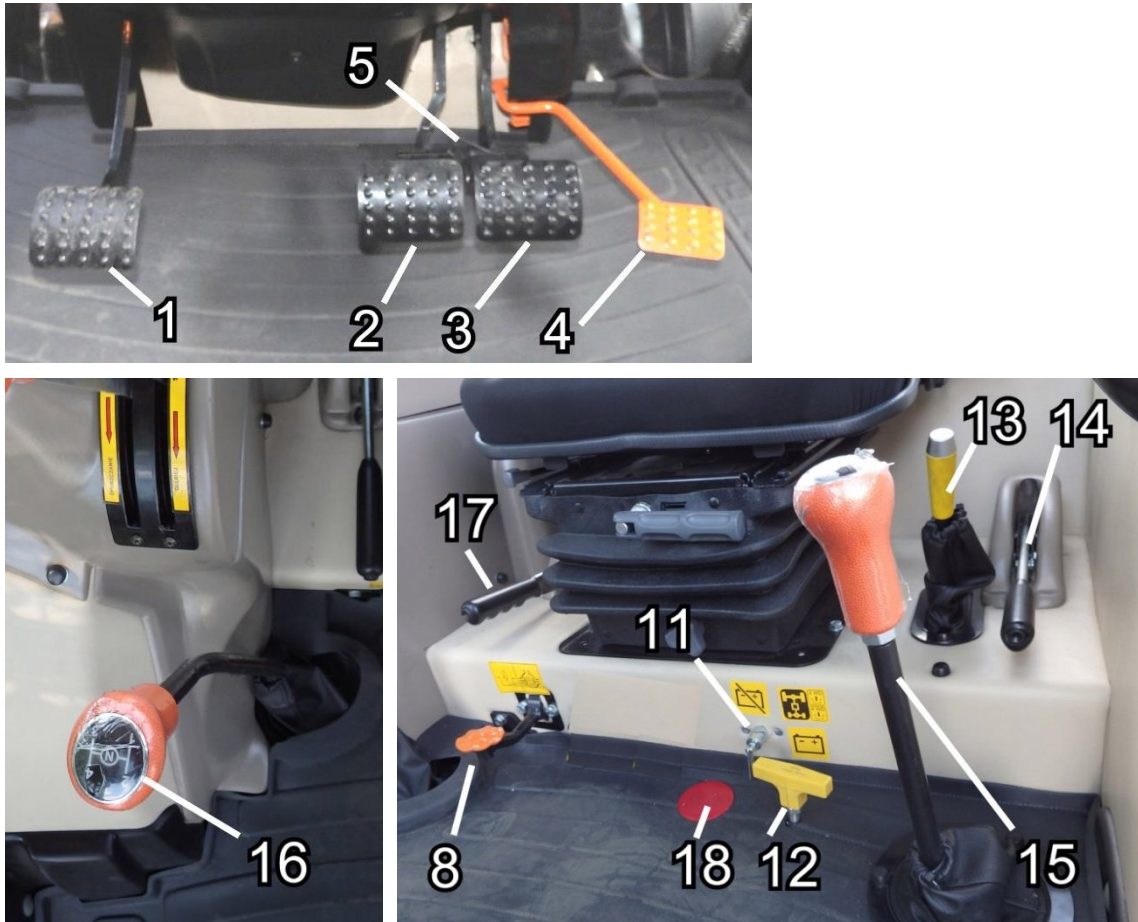

Fig. 3.4 Control levers and pedals, see description below

1. Clutch pedal

When this pedal is fully pressed, the drive to the wheels will be disengaged. Always depress the clutch pedal to engage or disengage a gear ratio. Clutch pedal must be depressed fully every time any of the three gear levers (main, range or shuttle) is operated.

NOTE: To start the engine must be depressed fully due to safe starting mechanism fitted in the tractor.

2, 3. Service brake pedals

The service brake system is mechanically actuated. The two brake pedals can either be used independently (to aid turning in confined spaces) or locked together using latch to provide a master pedal for normal braking. For independent braking, disengage the latch (5). Then the inner pedal (2) actuates the brake of rear L.H. wheel and the outer pedal (3) – the brake of rear R.H. wheel.

4. Foot throttle pedal orange

Operation of the foot throttle overrides the hand throttle (9 fig. 3.1) setting when increasing the engine speed. When the foot throttle is released, the engine returns to the speed set by the hand throttle. When foot throttle is used the hand throttle should be brought to the closed position.

5. Brake pedals locking latch

8. Differential lock lever

After the pedal is pressed rear wheels are connected, which prevents one wheel of slipping. In the field work when one wheel slips (with a small difference of drive wheels rotation speed), activate the locking pedal firmly.

In case of a definite slipping of one wheel (a large difference in drive wheels rotation speed):

- fully press the clutch pedal;
- activate the lock by pressing the lock pedal;
- slowly release the clutch pedal, keeping foot on the lock pedal.

The lock is released after releasing the pedal.

When the lock is on, the indicator light (20-Fig. 3.2) lights up.

With differential lock is engaged, set front wheels to straight-ahead driving.

11. Electric ground switch

12. Front wheel drive lever

This is used to engage the front drive.

The front drive should only be used when operating in field conditions. Do not operate the tractor in four wheel drive on the road (with the exception of uphill driving) as this may lead to premature wear of front tyres and excessive fuel consumption.

Before engage / disengage front drive, push clutch pedal.

13. PTO ON/OFF lever yellow

This lever has two positions as shown on the decal situated by the lever:

- backwards position – PTO ON,
- forward position – PTO OFF

NOTE: Tractor is fitted with safety switch device. Only the range lever center and PTO in neutral position enables engine starting. In any other range lever and PTO position the safety start switch automatically disconnects the starter motor.



14. PTO clutch lever

This is used to engage or disengage the drive to the engine speed PTO. When in its bottom position, the drive to the PTO is connected. To disengage the drive to PTO, pull the lever up, and to engage, press the button on the top of the lever and bring the lever down

Position of gear selection levers.



15. Range lever orange

The range lever is used to select high  or low  gear train. The shift pattern is placed on the top of the lever knob. Select the range according to the load and speed requirement. When shifting, the clutch pedal must be pressed

16. Main gear lever orange

The main gear lever is used to select the gearbox ratio and has four positions. The shift pattern is placed on the top of the lever knob. All gearbox ratios are of synchromesh type and enable shifting of gear while in motion. When shifting, the clutch pedal must be pressed.

Shuttle lever (4 - Fig. 3.1). orange

The lever has three positions:

- F - Forwards,
- Centre - Neutral,
- R - Rearwards.

To move the lever to position F or R - pull the lever towards the steering wheel from the neutral position.

17. Parking brake lever

Parking brake is used to lock the tractor rear wheels for parking and/or stationary operation. To engage the parking brake, latch the service brakes together and press them down. Then pull the hand lever up.

To release the parking brake, press the service brake pedals down, then press the button on the end of the lever and push the lever down.

18. Transmission oil filler plug cover

PTO 540E engagement lever

In case of need of operation with PTO high rotation (540E) implements, shift forward the lever placed above PTO shaft end (10 - Fig. 5.14).



WARNING:

Shift the PTO 540E lever only at PTO clutch (14 - Fig. 3.4) disengaged and PTO lever at neutral position (13 - Fig. 3.4).

3.3. Tractor cab

The safety type cab (fig. 3.5) protects the operator against adverse weather conditions and serious injuries in case of the tractor overturning. The cab has two doors which can be blocked in open position.

Ventilation of the cab interior is possible through deflectable side and rear windows, roof hatch and forced air circulation.

The window panes are made of a safety type glass. The R.H. side door is opened by means of key. To open, insert the key, turn it through 90°, remove the key and press the button. The other door is locked by means of latch located at the bottom of the lock.

To open the roof hatch (9), press the button on the hatch handle (10) and push the hatch upwards.

To open the tailgate (16):

- press the button on the tailgate handle (17),
- push the tailgate backwards.

The opening angle of the tailgate is maintained automatically due to the action of two damper.



WARNING:

In emergency, when leaving the cab through the door is impossible, the tailgate can be used as emergency exit. To open it fully, push sharply on the handle to disengage the dampers from their sockets.

Standard equipment of the cab comprises:

- led work lamps - 2 pcs. at the front (1) and 2 pcs. at the rear of the cab roof (7).
- adjustable side rear view mirrors (2),
- wipers of windscreen (3) and rear window (6),
- windscreen washer,
- air filter (5),
- ventilation or heating - cool or warm air blown through nozzles (11)
- Internal lamp (12),
- sun visor (14) with unlock on RH side (15),

Upon request, radio (27 – fig. 3.1) and loudspeakers (13) can be fitted

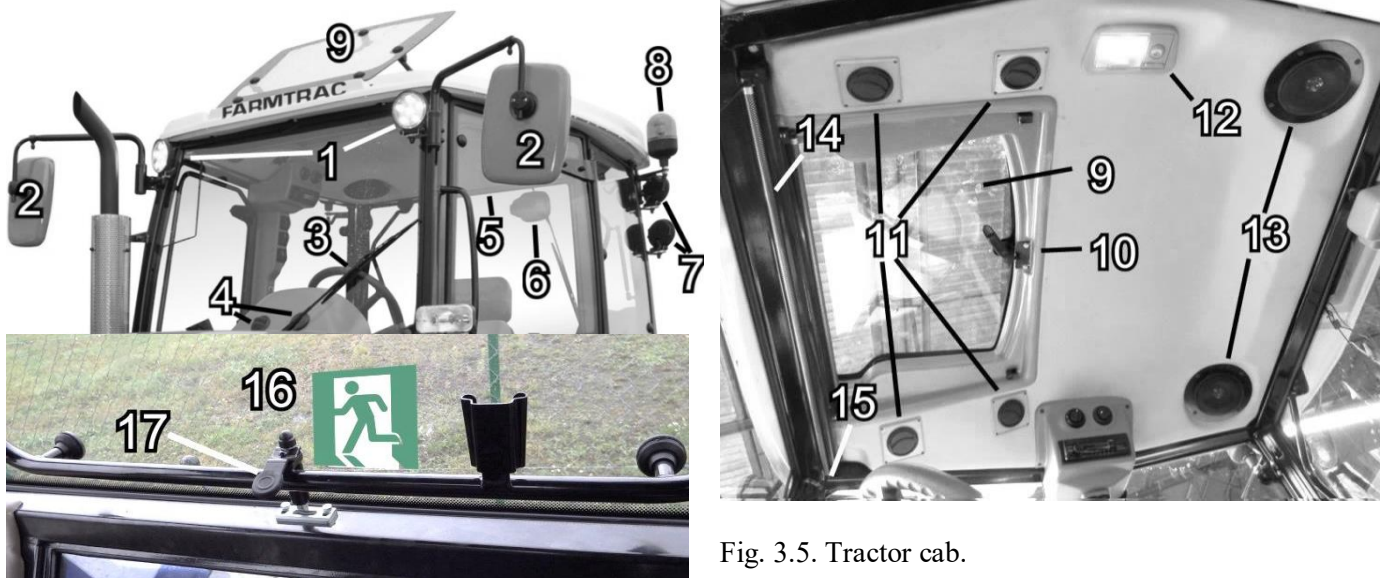

Fig. 3.5. Tractor cab.



WARNING:

To prevent falling while entering and leaving the tractor, use the handrail and steps. Remove of mud, snow, ice and debris from the steps.



WARNING:

Cabin does not satisfies the requirements of the prevention of exposure to hazardous substances in accordance with EN 15695-1: 2009. In order to protect observe the principles of protection specified for the product. Besides using appropriate filters, you should also use personal protective equipment.



WARNING:

Tractor in this version is not suitable for forestry work, therefore, the requirements of ISO 8084: 2003 for operator protection structure (OPS) are not met.

NOTE: Cabin complies with OECD Code 10 (Falling Objects) (FOPS)

NOTE: Burning rate of cab interior material such as the seat covering, wall, floor and headliner coverings not exceeding 150 mm/min in accordance with ISO 3795:1989.

3.4. Air conditioning control panel

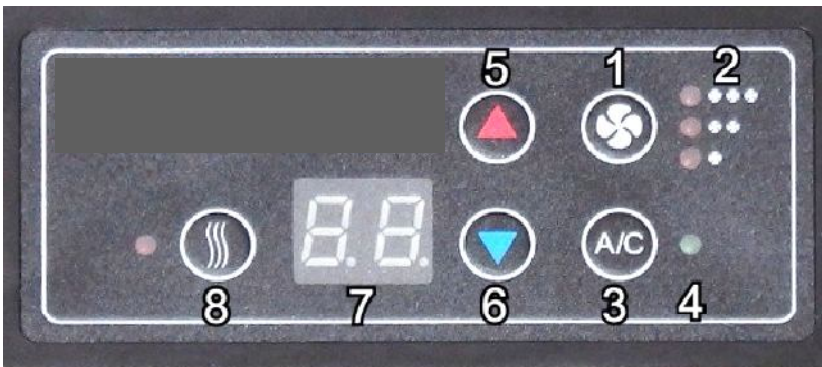

Fig. 3.6. Air conditioning control panel.

To start the air conditioning with the engine running, switch on the blower 1, select the desired ventilation range 2. Then start the air conditioner 3, the light 4 indicates the condition of the air conditioner. Set the desired temperature level with the control buttons 5 and 6. The set temperature value will be displayed on the display 7.

8 - function not supported.



WARNING:

The closed circuit of the air conditioning system is filled with a refrigerant R134a under pressure.

In no case should the tractor's air conditioning system be opened.

In case of damage (leaks, valve failures, etc.), please contact the Authorized Service.

Do not let the working medium into the atmosphere!

3.5. Operator's seat adjustments (Fig. 3.7)

Suspended seat, with a gradual, horizontal and vertical shift and smooth amortization stiffness regulation, depending on the operator weight.

Seat position adjustment elements are shown in Fig. 3.7.

Adjustment of seat suspension hardness to operator weight (50 ÷ 130 kg) is adjusted when the engine is running - pull lever 1 upwards shortly. The seat adjusts automatically to the weight of the operator.

Note: To avoid damage to the compressor use adjustment once for no longer than 1 minute.

Height adjustment can be done by turning the knob 2 to the left or right depending on your needs. Movement of the seat forward / reverse is blocked with the lever 3 in the forward position - the suspension does not move, the lever to backward position - suspension moves forward / backward. To move the seat horizontally, unlock the latch with lever 4 and move the seat to the desired position, then release the latch.

The level of armrests 5 inclination is adjusted using the knob at the bottom of the armrest.

The height of the headrest 6 can be adapted to individual requirements by pulling or inserting. To remove the headrest, strongly jerk up against the resistance of the latch limiting maximum extension.

To change inclination of the backrest is used the lever 7.

The seat has the ability to turn. To do this, pull the lever 8.

The function of rotation can only be used during tractor stay in order to facilitate entering the cabin.

The lap a safety belt should be fastened to the holes on either side of the seat.

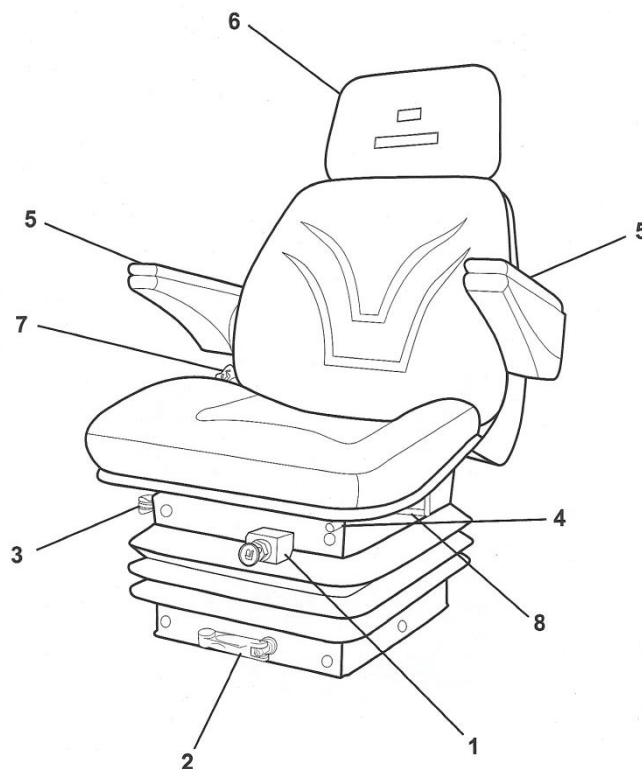

Fig. 3.7. Operator 's seat.

3.6. Passenger seat - option.

The tractor can optionally be equipped with a folding passenger seat located in the cab left side (fig. 3.8).

To unfold the seat, unlock the latch with the lever 1 and move the seat to the vertical position, then turn it by 90 ° counterclockwise and move it to the horizontal position and block the pin in the hole 2. After the passenger is seated, fasten the lap belt 3.



Rys. 3.8. Passenger seat - option.

4. OPERATION.

4.1. Tractor running in.

Your new tractor will provide long and dependable service if given proper care during the first 50 hours running in period and if serviced at the recommended intervals. Therefore, the following precaution should be taken during the running-in period:

- after reaching the operating temperatures, engage the tractor in work which will load the engine as near as possible to full load conditions,
- avoid prolonged operation without a load on engine,
- avoid overloading of the engine. Operating in too high gear under heavy load may cause excessive engine overloading. Overloading occurs when the engine will not respond to a throttle increase,
- to ensure proper clutch life, during the first 15 hours of operation keep careful watch on the clutch pedal free travel. If its decrease is found, adjust it immediately,
- frequently and regularly check the tightness of all external bolts, nuts. This is especially true of wheel retaining bolts/nuts,
- check the instruments frequently and keep the radiator and various oil reservoirs filled to the recommended levels.

After first 50 hours of operation, i.e. when the running in period is completed, first technical inspection should be carried out according to the list given in the Periodic Maintenance Chart – see Table 4, Section 5.1.

4.2. Starting and stopping the engine.

Before starting

Prior to daily start-up of the tractor, carry out the Daily Maintenance as described in Periodic Maintenance Chart (every 10 hours of operation) and particularly:

- make sure all safety shields are in place and secured properly,
- check coolant and engine oil levels and replenish as necessary,
- check the tension of belts and adjust as required,
- ensure the grill and the radiator are clear of debris to provide adequate engine cooling,
- switch on the earth switch (Fig. 11- 3.4),
- check operation of clutch, brake and throttle controls. All controls must operate freely and be adjusted correctly,
- carry out general inspection of tyres, tyre pressure and wheel nuts/bolts tightness. Observe for external signs of leakage and correct before operating the tractor,
- ensure that there is sufficient fuel in the tank and the fuel tap is open.
- check operation of lights and warning flashers. If tractor is to be driven on public roads, ensure the mirrors and slow moving vehicle emblem are in place,
- make sure the brake pedals are latched together and apply the parking brake
- make sure the main gear lever and range lever are in neutral position,
- set the hydraulic lift levers in “DOWN-LOWERING” position and the PTO selector lever is in neutral position

NOTE:	Tractor is fitted with safety switch device. Only the range lever center position enables engine starting. In any other range lever position the safety start switch automatically disconnects the starter motor.
--------------	---

NOTE:	The control levers of upper and lower couplers of the external hydraulics, when moved to operating position, will be kept there by the lock. To release the lever, move it by hand to the neutral position.
--------------	---

**WARNING:**

Do not leave this lever s in operating position, front or reverse, if not needed, otherwise the hydraulic pump may get damaged.

**WARNING:**

Start the tractor only from the operator's seat

Starting the engine**Normal starting procedure** (at the ambient temperatures above 5°C)

To start the engine, proceed as follows:

- engage clutch pressing clutch pedal,
- turn the ignition switch key (14–Fig. 3.1.) fully to 3 position to engage the starter motor,
- release the key the moment the engine starts, allowing it to return to 2 position,
- release the clutch pedal slowly.

NOTE:

Do not crank the engine for more than 5 seconds. Allow the starter to cool (at least 30 seconds) between intervals of cranking.

Cold weather starting procedure (at ambient temperatures below 5°C)

In such case the flame plug must be used.

- engage clutch pressing clutch pedal,
- prior to cranking the engine, turn the key to the 2 position, and hold it to engine pre-heat indicator light is off. Then turn the key clockwise to the 3 position. When the engine starts, return the key again to the 2 position,

In specific conditions, in order to protect engine components against effects of low temperatures, the control system limits the engine speed after start and blocks full power development. The engine gets normal operating parameters after reaching the minimum temperature. 10° C.

Before starting the engine at low temperatures, it is also important to charge the battery properly.

Excessively low battery voltage may cause unusual behavior of the engine control module.

In that situation, it may be helpful to shut down and restart the engine again.

Stopping the engine

Stopping the engine immediately after it has been working under load can result in overheating and accelerated wear of the engine components.

NOTE:

If the engine has been operating at high rpm and/or high loads, run at low idle for at least three minutes to reduce and stabilize internal engine temperature before stopping the engine.

Avoiding hot engine shutdowns will maximize turbocharger shaft and bearing life.

**WARNING:**

Before leaving the tractor cab remove the key from the ignition.

**WARNING:**

Do not to stop the engine by turning off the battery electric earth switch. This could damage the engine control module. Battery switch should be off at least 30 seconds after the engine is immobilized.



Fig. 4.2. Ignition switch 4 position.

0. OFF

1. Switches on electrical consumers when the engine is not running.

2. In this position the glow plugs are energized for cold engine starting.

3. In this position starter motor is turned on. When the key is released, the key returns automatically to the 2 position.

By turning the key back to position 0 the engine is switched off.

4.3. Driving the tractor.

WARNING: Prior to commencing work, the operator should be familiar with the function and operation of all control levers and indicators.



After starting the engine:

- depress the clutch pedal, then select the desired speed range, gear and direction gear,
- release the parking brake lever,
- increase the engine speed slowly and simultaneously release the clutch pedal slowly,
- release the clutch pedal fully and slowly operate the throttle until desired engine speed is reached.

Selecting the correct gear

Select the gear which will give the best fuel consumption without overloading the engine or transmission. Also remember that ground conditions in the same field may vary almost every few meters, therefore select the gear in which the engine will operate satisfactorily at about three-quarters of its maximum power.

Never work the tractor by slipping and re-engaging the clutch and at all times avoid riding the clutch pedal which can cause overheating, and will lead to clutch failure.

- WARNING:**
1. Avoid pressing the clutch pedal all the time.
 2. Do not move the gear lever, the range selector lever, unless the clutch pedal is pressed, when the tractor is moving.
 3. Never move down on slopes with the tractor in gear and the clutch disengaged.
 4. For road work, take hand throttle to minimum position and use the foot throttle only.
 5. When tractor is towed, the engine must run (due to hydrostatic steering system) and the gear lever place in neutral position.

Recommendations aimed at tractor operating efficiency and fuel saving.

1. Match the attached implement size so that the engine could operate at over 75% of its power.
2. Avoid unnecessary tractor idling and reduce the time spent on headland turns and travels to the field.
3. Use correct tyre pressure for a given work.
4. Use the ballast weights reasonably.
5. Match the trailer load capacity correctly and utilize it to the highest extent possible.
6. For field transport make use of single axle trailer preferably.
7. Make use of Draft Control for controlling the working depth of mounted soil engaging implement to the highest extent
8. Look after the efficiency of the fuel system and carry out the maintenance and adjustments as stated in this book.
9. Use recommended fuels and lubricants only.

Towing

Before towing the tractor, move the PTO lever, the range selector lever and the main gear lever into neutral. The tractor must be towed at safe speed using a rigid drawbar.

WARNING:



When the engine is stopped the hydraulic power assistance to the steering does not operate. The tractor can then be steered manually. In this situation the tractor must move slowly with extreme caution.



Fig. 4.3.1. Tractor towing hitch.

Braking system

WARNING:



1. Before driving on the road, always latch the brake pedals together.
2. Independent braking may only be used to assist turning on headlands of a tractor with mounted implements.
3. When the tractor is operated for stationary work, even if only for short periods always engage the parking brake

When attaching a trailer, or trailed machines to the tractor, ensure that the trailer air braking system is connected.

To connect the trailer braking system to the tractor braking system, proceed as follows:

- engage the parking brake (this will cause the air pressure in the hose drop down to the atmospheric pressure,
- couple the trailer and tractor air couplers,
- release the parking brake.

WARNING:



Never start towing of a trailer with the air pressure gauge pointer in red zone. Allow time for the compressor to fill the air reservoir. Insufficient air pressure in the system is then also indicated by air pressure drop warning light which illuminates red.

Front drive axle

The drive to the front wheels is transmitted from the drop box by the drive shaft, crown wheel and pinion and differential mechanism to the front axle final reduction units. As a standard equipment the "limited slip" type of differential is fitted (self-locking).

WARNING:



Operation in four wheel drive is intended for field work only. Do not use the tractor in four wheel drive on roads or dry land.

Rear differential lock

If during the field work one of the rear wheels starts to slip (there is a small difference in rotational speed) engage the differential lock by pressing the differential lock pedal down firmly,

In case one of the wheels is slipping significantly (there is considerable difference in rotational speed) proceed as follows:

- fully depress the clutch pedal,
- engage the differential lock by pressing its pedal down,
- release the clutch pedal slowly, while maintaining foot pressure on the differential lock pedal.

To disengage the differential lock release the pedal. If the lock fails to disengage, steer slightly to either left or right or depress for a moment one of the brake pedals (independent).

- | | |
|---|---|
|  | <p>WARNING:</p> <ol style="list-style-type: none">1. Do not engage the differential lock with one wheel rotate and the other stopped.2. Do not turn the tractor with the differential lock engaged.3. Operation with differential lock engaged is intended for field work only.4. Do not use the tractor with differential lock engaged on roads or dry land. |
|---|---|

4.3.1. Regeneration procedure of DPF filter

Diesel particulate filter was applied in an exhaust system for exhaust gas purification. Particulates (soot) generated during the engine working are collected and burnt in a diesel particulate filter.

In a typical engine working cycle passive regeneration of the exhaust gas occurs.

Under conditions when engine working cycle doesn't provide sufficient exhaust gas temperature soot increase accumulation of in the filter.

After reaching level of 90 – 130 % active regeneration starts up signaled by of high temperature

exhaust system control light with symbol  decreasing the level of soot to approx. 20%. Active regeneration starts when the engine runs at a speed above 1200 rpm / min. Then, the engine speed may drop below 1200 rpm / min. But not less than 950 rpm / min. Idle speed will be temporarily increased to 950 rpm / min.

During the automatic regeneration normal tractor working can be carried out.

If you cannot carry out active regeneration at a given moment, press the switch DPF filter

regeneration control for at least 2 seconds on the side of symbol .

If the active regeneration is not occurred in the range of 90 - 130% soot accumulation, control lamp of



high degree accumulation of soot in the filter DPF is on with symbol . This situation can occur in the absence of conditions to start active regeneration, or when the user postpones active regeneration. In such a situation, it is recommended to manually extort active regeneration.

The tractor should be stopped, the handbrake applied and the DPF filter regeneration control switch

press for at least 2 seconds on the side of symbol .

The warning lamp needs of active regeneration lights up until the completion of process of active regeneration.

If the active regeneration is still postponed or not extorted manually, the accumulation of soot in the filter increases to the level of 170%, warning light comes on about improper engine working with

symbol  and control lamp of high degree accumulation of soot in the filter DPF  will continue to lights up. The control system will reduce engine power by 25%. **Under these conditions, the engine control system disconnects the automatic regeneration and only manually extortion of regeneration is possible.**

In case when accumulation of soot in the filter reaches the level of 230%, engine must be stopped.

Warning light comes on about engine failure , The control system will reduce engine power by 55%. Service actions must be carried out to restore proper conditions of engine working.

WARNING: Repeated manual postpone the process of active regeneration may lead to damage the DPF and the necessity of its replacement.



4.4 Power take-off (PTO).

Power take-off shaft is placed in the rear axle housing and its end rotates to the right (from rear of the tractor), diameter 35 mm with 6 splines as per PN-77/R-36101 standard with ring groove for safety attachment of the driven implement telescopic-articulated shaft.

PTO shaft is covered with the PTO shaft cup when not in use.

NOTE:	<ol style="list-style-type: none">1. After attaching mounted implement carefully raise and lower it using Position Control lever. Check clearance and the drive shaft slide range/articulation.2. When attaching trailed implements ensure the drawbar is correctly set.3. Check all four wheels when carrying out stationary PTO work.
--------------	---

	<p>WARNING: Before operating the tractor with PTO driven implements, familiarize yourself with the safety precautions given below and strictly observe them:</p> <ol style="list-style-type: none">1. Before connecting, disconnecting, cleaning or adjusting the PTO driven implements, disengage the PTO drive, stop the engine, remove the key, apply the hand brake and make sure that the PTO drive line has stopped.2. Do not operate the PTO driven implements without the master shield fitted.3. Make certain the implement drive shaft is securely locked on the tractor PTO shaft before starting the engine.4. After locking the drive shaft on the tractor PTO shaft, attach the drive shaft guard safety chains to the master shields.5. Fit the removable cap when the PTO drive line is not in use.
---	--

Operating the rear PTO

To obtain 540 rpm at the PTO:

- set the engine speed to 1728 rpm,
- set the PTO clutch lever 14 (Fig 3.4) to disengaged position,
- bring the PTO ON/OFF lever 13 (Fig.3.4) to engaged position,
- set the PTO clutch lever 14 (Fig 3.4) to engaged position.

NOTE:	Set the PTO clutch to disengaged position while shifting the PTO selector lever to engaged or neutral position.
--------------	---

When connecting the drive shaft to the tractor and to the implement, this should be carried out strictly in accordance with the drive shaft or implement manufacturer operating instructions.

If PTO driven implements is attached to the drawbar, then the drawbar should be set to the position which ensures that the horizontal distance between the end of the PTO shaft and the pin hole in the end of the drawbar is at least 400 mm.

	<p>WARNING: To avoid inadvertent movement of the implement, keep the PTO selector lever in neutral after each use.</p>
---	---

	<p>WARNING: Before select PTO speed disengage PTO drive.</p>
---	---

Independent PTO drive means that the PTO shaft rotates proportionally to engine rotation. There is possibility to select two speeds: 540 rpm and 540E.

If required to drive implements of different PTO speed (540E), set the engine speed to 1251 rpm, select forward position of the lever (10 Fig. 5.14) placed above PTO shaft end. When 540E PTO is engaged the relevant symbol appears on the instrument panel (Fig. 3.3.2).



WARNING:

When 540E PTO is engaged don't use implements adapted to low PTO rotation to avoid damage of the implement and danger

4.5. Tractor hydraulic system.

Your tractor is equipped with a hydraulic system providing accurate and sensitive control over a wide range of operating conditions.

This system provides the following functions:

Draft Control – is most suitable for mounted soil engaging implements. Changes in the working depth or soil resistance cause the draft loading on the implement to increase or decrease. This change in draft loading is sensed through the top link of the three-point linkage and the hydraulic system responds by raising or lowering the implement to restore the draft loading. In this way a uniform draft load is maintained on the implement.

Position Control – provides accurate and sensitive control of implements such as sprayers, rakes, mowers etc., that operate above the ground. Position control would not normally be used with soil engaging implements unless it is essential to maintain a constant position of the equipment regardless of the draft load.

External hydraulics control – is provided to control the external equipment that requires hydraulic power for its operation, such as trailer tipping, loader operation, hydraulic motor drive, etc.

4.5.1. Hydraulic lift system.

Control levers (Fig. 3.1)

- Draft Control lever (24- Fig. 3.1) (next to the seat), is used to adjust the draft i.e. working depth,
- Position Control lever (23- Fig. 3.1) (next to the mudguard), is used to adjust the position/height of the implement and lets you lift or lower the implement,

The Position and Draft Control levers are used in conjunction to raise or lower the three-point linkage (and implement) to the required height and adjust the working depth.

In order to operate the three-point linkage, the external hydraulics control lever must be kept in neutral position.



WARNING:

To avoid inadvertent movement of the implement, keep the PTO ON/OFF lever in OFF position after each use (13 – Fig. 3.4).



WARNING:

1. Do not transport or attach implement when the hydraulic system is in Draft Control. Use Position Control for these operations only.
2. Always lower the implement to the ground before stopping the engine.

Draft control operation

Move the Draft Control lever in the sector to find the point near the centre where the lift links neither raise nor lower. This is the neutral point.

Lower the implement into work using the Draft Control lever. Push the lever forwards to increase the draft loading. Pull rearwards to reduce the draft loading. In most circumstances the forwards movement of the Draft Control lever will increase implement depth and rearwards movement will reduce the depth.

Once set, the tractor hydraulic system will automatically adjust the implement depth to maintain an even pull on the tractor and so reduce wheel slip to a minimum.

When lowering the implement into work, push the draft control lever down to the bottom of the quadrant to ensure positive engagement of the implement in the ground, then immediately raise the draft control lever until the required implement depth is achieved.

NOTE:

When operating in Draft Control, the Position Control lever should normally be at the bottom of the sector gear. However, the Position Control lever may be used in conjunction with Draft Control to limit the maximum depth of correction with achievement of more even depth of cultivation in fields with widely varying soil conditions.

When grading and back-filling with light equipment, such as rear blade, it may be desirable to prevent the blade from “diving”. This is accomplished by using the Position Control lever in conjunction with the Draft Control lever. See “Draft Control operation with Position Control” on this page.

Position control operation

Set the required implement height/depth using the Position Control lever. Pull the lever back to raise the implement, push forward to lower. The implement height/depth is relative to the position of the lever in the quadrant.

NOTE: When operating in Position Control the Draft Control lever should be pushed down to the bottom.
--

Draft control operation with position control

Position Control may be used together with the draft control as follows:

Set the Position Control lever at the maximum desired implement depth. The hydraulic system will not lower the implement below this depth. This will also prevent “diving” which may be encountered with light equipment, such as a rear blade, when grading or back-filling.

Adjust the Draft Control lever for the maximum required draft load (pull).

The hydraulic lift system will now provide normal draft response within the range set by the position control. This adjustment provides a more uniform depth while maintaining an even pull in widely varying soil conditions.

4.5.2. External hydraulics control.

The external hydraulic valves controls the oil flow to the hydraulic equipment found on farm machinery, namely: single- and double-acting ram cylinders and hydraulic motors.

NOTE:	It is important that the components are identified correctly before the machine or implement is attached to or operated by the tractor, otherwise damage to the system may result.
--------------	--

External hydraulic valves are located under the cab platform and connected through piping system to quick-release couplers at the back of the tractor (1 – Fig. 5.14)

The external hydraulic system is fitted with three spool valves with 6 quick-release couplers.

System is controlled with a two levers (21, 22 - Fig. 3.1). Depending on lever position the pressure appears on relevant coupler.

Levers have three service positions (Fig. 4.5.2).

Lever B is fitted with detent which locks the lever in backward service position.

The lock position of spool valve is designed to supply another hydraulic distributor or hydraulic motor.

To release the lever from locked position, must be manually moved. In other position, the lever when released, automatically returns to the neutral position.

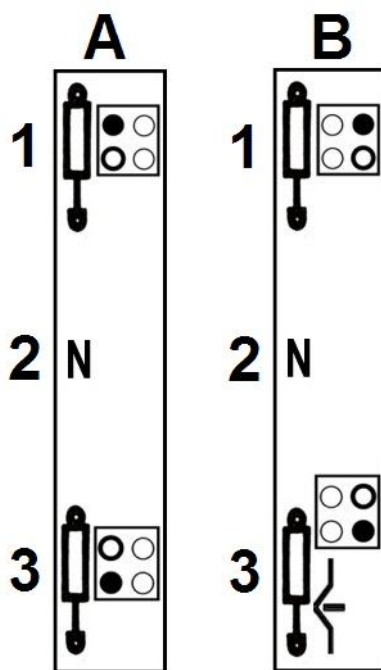

Quick coupler label		Quick coupler label	
	Pressure at upper left quick-coupler, return at lower left quick-coupler		Pressure at upper right quick-coupler, return at lower right quick-coupler
	Pressure at lower left quick-coupler, return at upper left quick-coupler		Pressure at lower right quick-coupler, return at upper right quick-coupler

N - Neutral position

- Lock position

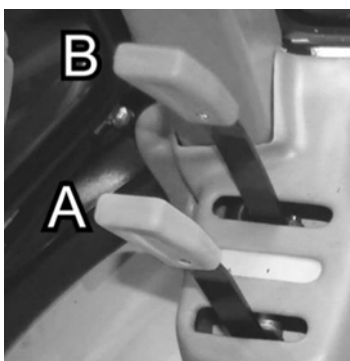

Fig. 4.5.3 External hydraulic control levers.

WARNING: Do not leave the joystick in its front lock position unless needed, to avoid hydraulic pump damage.



WARNING: Leaking fluid under pressure can penetrate the skin causing serious injury. Avoid the hazard by relieving pressure before disconnecting hydraulic lines. Tighten all connections before applying pressure. Search for leaks with a piece of cardboard. Protect hands and body from high pressure fluids. If an accident occurs, see a doctor immediately or gangrene may result.



To operate a spool control valve, connect the remote cylinder feed hose to the lift coupler by inserting the hose in the coupling after removing the dust cap. Ensure that the hose is properly seated. The return hose from the double-acting cylinder must also be connected to the drop coupler.

WARNING: Before connecting or disconnecting hydraulic hoses at the remote couplers, stop the engine and relieve the pressure in the circuit by moving the joystick fully forward, fully backward, sideways and then to neutral position.



NOTE: Before connecting remote cylinder hoses, thoroughly clean the connections to prevent oil contamination. Remote cylinders are operated by oil drawn from the tractor transmission system. Therefore, always check and replenish the transmission system oil after remote cylinder equipment has been connected and cycled a few times

If hoses are accidentally disconnected from the tractor during use, clean tip and coupler receptacles. Hoses can be reinstalled as previously described with minimal loss of oil.

WARNING: Make sure that the amount of oil in the gearbox does not fall below the minimum level. Take special care when cleaning the hydraulic unit on the implement/equipment so as not pollute the oil in the transmission housing.



4.6. Equipment attaching on three-point linkage.

The tractor hydraulic lift system with three-point linkage (see Fig. 4.6.1 and 4.6.3) facilitates control of implements and machines from operator's place.

The three-point linkage consists of following elements:

1. Top link (2) it is fitted with locking sleeve and lever to adjust the length of the link. It can be attached to one of three openings in top link rocker (5). When transporting the tractor, hook the link over the lug.
2. Lower links (8).
3. Lift rods, right and left (6) attached lower links with lift arms. Both lift rods length is adjusted by means of rotary handles (7). To turn the handle pull it upwards to unlock.
4. Stabilizer bars protect implements of excessive lateral movement. The external bars are adjustable with means of a pins (10).
5. Quick couplers of lower links (11) and top link are designed to attach implements to three point linkage.

Attaching implement to the three-point linkage

- shift the upper transport hitch to top position (2 - Fig. 4.6.2),
- remove the drawbar (3 - Fig. 4.6.2) after putting out pins (6 - Fig. 4.6.2),
- move back the tractor to the implement aligning the ends of lower links (11 - Fig. 4.6.1) with the implement hitch pins,
- put ball joint sleeves on implement hitch pins to attach the implement to tractor lower links,
- using the Position Control lever (23 - Fig. 3.1.), raise the lower links to the position in which implement hitch pins join tractor lower links quick couplers,
- make sure the self-locking latch of quick couplers blocked the ball joints on implement hitch pins,
- apply the parking brake,
- level the implement in horizontal plane by changing length of lift rods.
- depending on the implement, attach the top link (2 - Fig. 4.6.1) to a selected hole of the lift rocker and then to the implement cross shaft adjusting its length as necessary,
 - lower hole – light implements – Hydraulic system is more sensitive to load changes
 - upper hole – heavy implements – Hydraulic system is less sensitive to load changes
- adjust the stabilizer bars for side swing (Fig. 4.6.2),
To lengthen or shorten the stabilizers set the pin (10 - Fig. 4.6.2).

Make sure the stabilizers have the same length.

In transport position stabilizers length should be set as they not to be strained.

When operating with plough implement the length of stabilizers should be set such as side mowing did not exceed 125 mm at end of each lower link.

NOTE:	When attaching mounted or semi mounted equipment to the three-point linkage, or when coupling trailed equipment to the drawbar, ensure that there is adequate clearance between the implement and the tractor. The clearance in the raised position should be checked by raising the implement carefully in Position Control. Check the swing clearance by performing a series of left and right hand turns with the tractor and implement combination.
--------------	---

WARNING:	Do not transport or attach the implement when the hydraulic system is in Draft Control. Always use Position Control for these operations.
-----------------	---



Detaching the implement

- select level and firm ground to detach the implement and lower the implement to the ground,
- apply the parking brake and stop the engine,
- ensure all hydraulic pressure is relieved,
- turn the leveling lever control to level the implement with the ground, if needed,
- support the implement so that it will not tip or fall when detached from the tractor,
- detach the top link and lower links from the implement frame.

WARNING: Never tow implements attaching to the hydraulic lift rocker

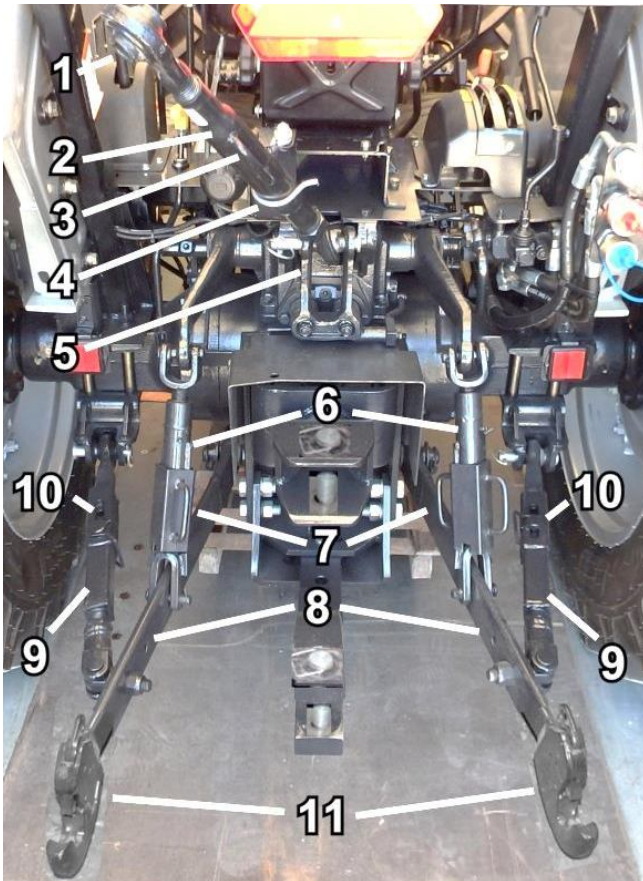

Fig. 4.6.1. Three-point linkage
1- Ball joint. 2- Top link. 3- Top link lock handle.
4- Top link support. 5- Top link rocker. 6- Lift rods.
7- Lift rods rotary handles. 8- Lower links, 9- External stabilizer. 10- External stabilizer pins.
11- Quick couplers.

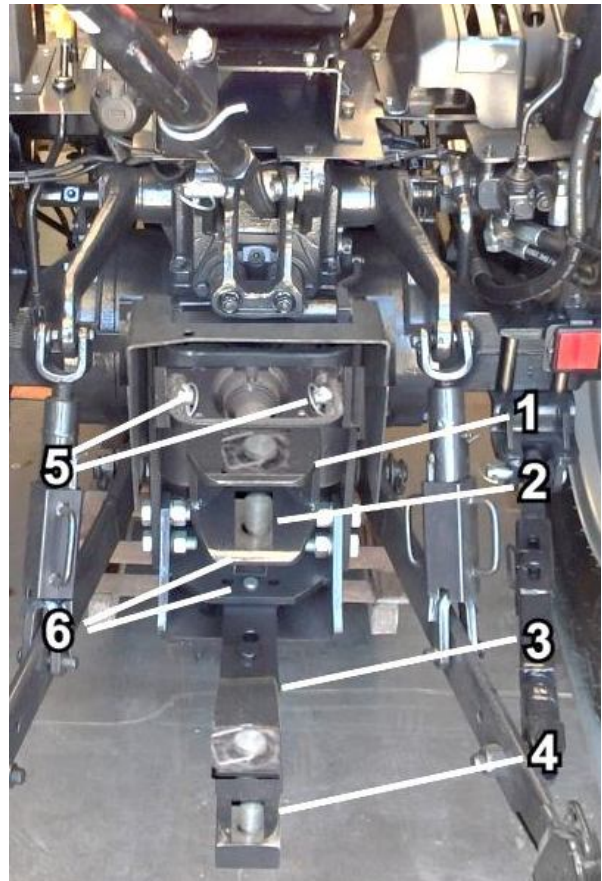

Fig. 4.6.2. Hitches
1- Upper hitch. 2- Upper hitch pin.
3- Tractor drawbar. 4- Tractor drawbar pin.
5- Upper hitch locking pins.
6- Drawbar attaching pins.

4.7. Attaching trailed machines and implements.

Apart from the three-point hitch (Fig 4.6.2), the machines and implements can be attached to:

- upper transportation hitch (for 2-axle trailers),
- tractor drawbar,

Upper transportation hitch (1 - Fig. 4.6.2) – is used for hitching a two-axle trailers. Secure the hitch attaching pin with a cotter. This hitch must be detached when attaching implements to the three-point hitch. To disconnect the hitch move out pin (5 - Fig. 4.6.2)

NOTE: This hitch must be detached when attaching implements to the three-point hitch.
--

Tractor drawbar (3 - Fig. 4.6.2) – is used for hitching trailed machines and implements.

4.8. Tractor weighing.

For maximum performance in heavy draft conditions weight should be added to the tractor in the form cast iron weights. Front-end ballast may be required for stability and steering control when weight is transferred from the front to the rear wheels as the implement is raised by the tractor three-point linkage.

Weighing limitations

Additional weights can be applied:

- to front weight carrier - 6 wafer weights of 22 kg each and central tow hook of 40 kg can be dismantled in case of front axle unload need – installation of front loader 40 kg (6 x 22 + 40 kg = 156 kg),

WARNING: Take special care when carry and assembly rear wheel weights and front weight carrier, due to it's high weight – should be done by two persons.



4.9. Jacking Up Tractor.

Jacking Up Tractor - Lifting Points

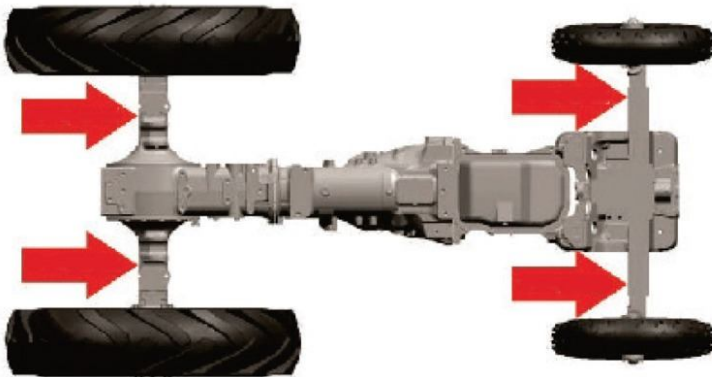

Fig. 4.9. Lifting points recommended for jacking up the tractor

4.10. Engine bonnet opening.

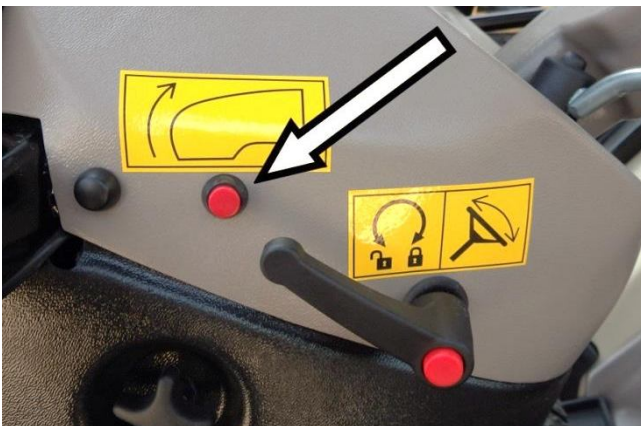

Fig. 4.10. Engine bonnet electromagnetic lock release button.

To open engine bonnet push the button (Fig. 4.10). The bonnet is raised and held in position with gas springs.

5. MAINTENANCE AND ADJUSTMENT.

5.1. Periodic maintenance chart.

Table 4

Hours of operation	Service requirements	Check	Clean	Lubricate	Change	Adjust Replenish	Drain Remove
Every 10 Hours	Engine oil level	X				X	
	Dry air cleaner dust collector						X
	Radiator coolant level	X				X	
	Radiator matrix and oil cooler		X				
	Water in air reservoir (if fitted)						X
	Dry air cleaner outer element		X				
First 50 hours	Engine oil and oil filter	A	A		A		A
	Fuel filter(s)	A	A			A	
	Radiator coolant level	A				A	
	Dry air cleaner outer element		A				
	Air compressor (if fitted) and fan V-belts tension	A				A	
	Clutch pedal free travel	A				A	
	Transmission and rear axle oil level	A				A	
	Hydraulic oil filters					A	
	Front drive axle oil including final reduction units					A	
	Front drive axle oil breather		A				
	Braking system (including foot brake valve)	A				A	
	Tightness of trailer air braking system (if fitted)	A				A	
	Operation of electrical equipment	A				A	
	Battery electrolyte level and concentration	A				A	
	Lubrication acc. to the Grease Points Chart.				A		
	Leakage of oil and coolant (after road test)	A				A	
Tightness of external threaded connections (wheels, manifolds, cab, ballast weights,	A				A		
Tires, condition, inflation	A				A		
Every 300 Hours	Fuel filter(s)	X	X				X
	Engine oil and oil filter				A	X	
	Condition of tyres and pressures	X				X	
	Lubrication acc. to the Grease Points Chart.			X			
	Dry air cleaner outer element	X	X				
	Transmission and rear axle oil level	X				X	
	Front drive axle oil including final reduction units	X				X	
	Air compressor (if fitted) and fan V-belts tension	X	X			X	
	Clutch pedal free travel	X				X	
	Tightness of external threaded connections (wheels, manifolds, cab, ballast weights, 3-point linkage etc.)	X				X	
Cabin air cleaner element		X					

	Hydraulic oil filter				A		
	Braking system adjustment	A				A	
	V-belts tension	A				A	
	Tightness of trailer air braking system (if fitted)	A				A	
	Tightness of external threaded connections (manifolds, cab, 3-point linkage)	A				A	
	Turbo Filter				A		
Every 600 Hours	Dry air cleaner outer element				X		
	Fuel filter element				X		
	Fuel system breathing					X	
	Front wheels toe in	A				A	
	Condition of all lines (fuel, hydraulic, electric) and tightness	A				A	
	Starter motor pinion	A	A				
Every 900 Hours or every year	Transmission and rear axle oil level				X		
	Front drive axle oil including final reduction units				X		
	Fuel tank and air reservoir (if fitted)		A				
	EGR Valve		X				
	EGR Cooler		X				
	Throttle actuator valve		X				
	Cooling system					X	X

NOTE

Carry out maintenance every specified number of operation hours

- it means, that carrying out maintenance after 300 hours of operation, also should be carried out maintenance after 10 and 50 hours of operation etc.
- **A – maintenance to be carry out by Authorized Service Shop**

5.2. Lubrication.

5.2.1. Oils and liquids.

Following lubricating grades of oil are applicable in Farmtrac tractors:

Table 5

Liquid kind	Recommended liquid	Application	Capacity in liters
Engine oil	API CK-4 10W-30	Oil sump	6,0
Transmission oil	API GL-4 10W-40	Rear axle, Transmission Hydraulic lift, Rear reduction gears	30
	API GL-4 80W-90	Front axle	5,9
Coolant	GLIKSOL	Cooling system	12,9
Diesel fuel • summer • interim period • winter	B w/g PN-EN 590+A1:2017 D w/g PN-EN 590+A1:2017 F w/g PN-EN 590+A1:2017	Fuel tank	80
Wind screen spray		Wind screen spray container	1,5
Hydrostatic steering system oil	ATF	Steering system oil reservoir	2,5
Grease		Grease points as per Table 6	0,15 kg

5.2.2. Greases.

In the FARMTRAC tractor grease is applied by hand or using grease gun in grease fittings. Greasing points are shown in Table No. 6.

NOTE: Clean the grease gun and grease point nipple, before and after lubrication.

Table 6

	Grease point (Fig. 5.2.1)	Lubricate every hours of operation
2	Bearing of reducer pivot stub axle of front axle	50
3	Telescopic stabilisers	50
4	Upper and lower hanger points	50
5	Articulated joints of reducer drive shafts	50
6	Upper and lower securing points of hydraulic cylinder	50
7	Rotation axis of lift arms	50
8	Articulated joints of front axle drive shaft	50
9	Articulated joints of front axle drive shaft	50
10	Front axle drive shaft sleeves	50
11	Front axle pivot pin	50
12	Front axle pivot pin	50

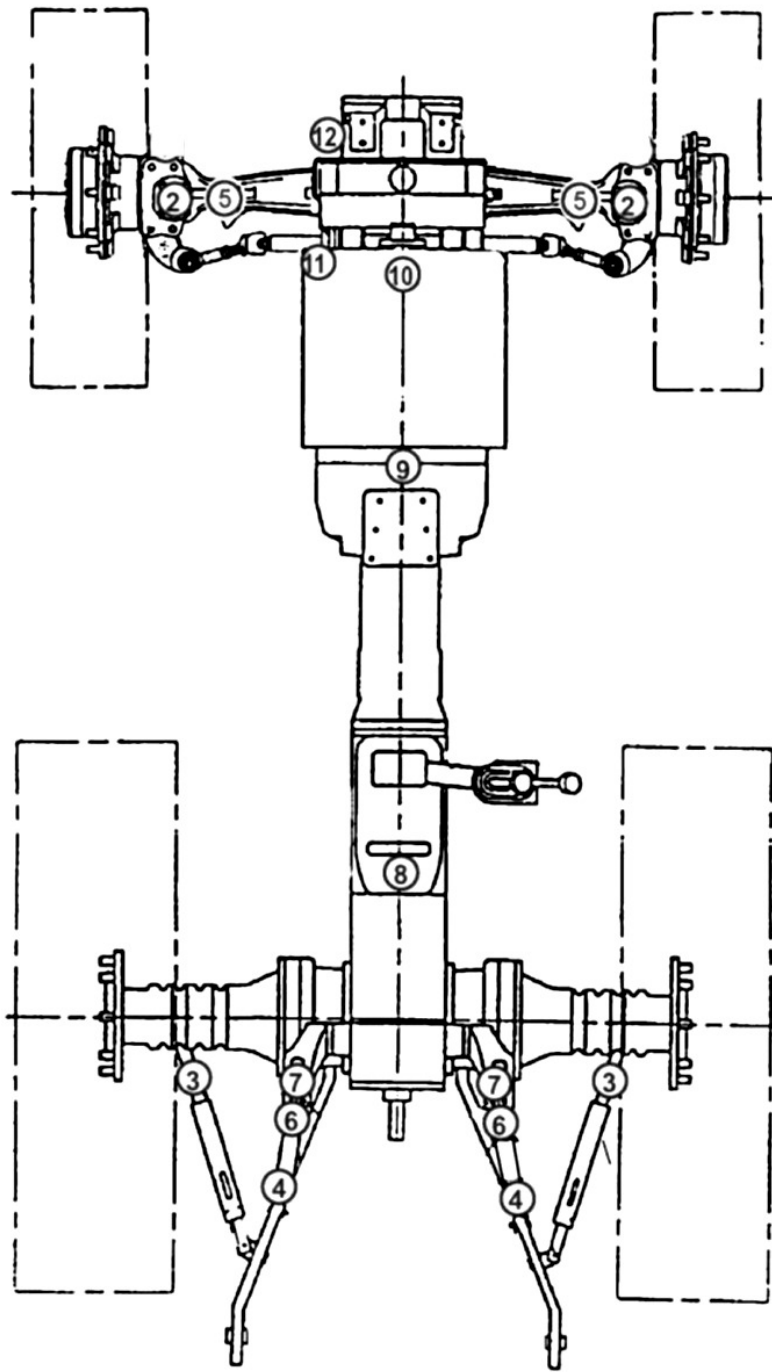

Fig. 5.2.1. Grease points.

5.2.3 . Reservoir filling.

Keep oil and grease in tight and clean containers.

Clean control & filler plugs and area around before oil / coolant level check. Check and replace, if necessary, plug seals.

Fill fuel tank using thick strainer funnel with relevant fuel according to ambient temperature.

Fill radiator with antifreeze coolant available on the market.

Liquid top levels are shown in table No. 7.

5.3. Engine.

5.3.1. Engine lubrication system.

Engine oil and filter change

Check the engine oil level every 10 hours of operation, or daily. Before checking the oil level, stop the engine and wait for a short period to allow the oil to drain back into the sump (tractor must be on level ground). Check the oil level by means of the dipstick (3-Fig. 5.3.3). If necessary, remove the filler plug (5- Fig. 5.3.3) and top up with fresh oil to the upper mark on the dipstick. Do not overfill.

Change the engine oil and oil filter as specified in table 4.

To change the oil, proceed as follows:

Warm the engine to operating temperature. Stop the engine, remove the drain plugs on oil sump (4-Fig. 5.3.2) and collect the oil in a suitable container. Unscrew and discard the oil filter (7-Fig. 5.3.2),. Clean the area around the filter. Lubricate clean engine oil around the rubber seal of a new filter and install on the tractor. Screw up until the faces just meet, then tighten a further 3/4 of a turn. Do not over tighten.

Replace the drain plug, remove the filler plug, and refill the engine with clean oil. Replace the filler plug.

Run the engine for a minute or so, to circulate the oil, then stop the engine. Wait for a short period to allow the oil to drain back to sump, then check the oil level by means of the dipstick.

Add clean oil, as necessary, until the oil reaches the upper mark on the dipstick.



Fig. 5.3.1 Front of the engine.

- 1- Air cleaner cover,
- 2- Windshield washer spray tank,
- 3- Horn,
- 4- Engine radiator mesh cover.

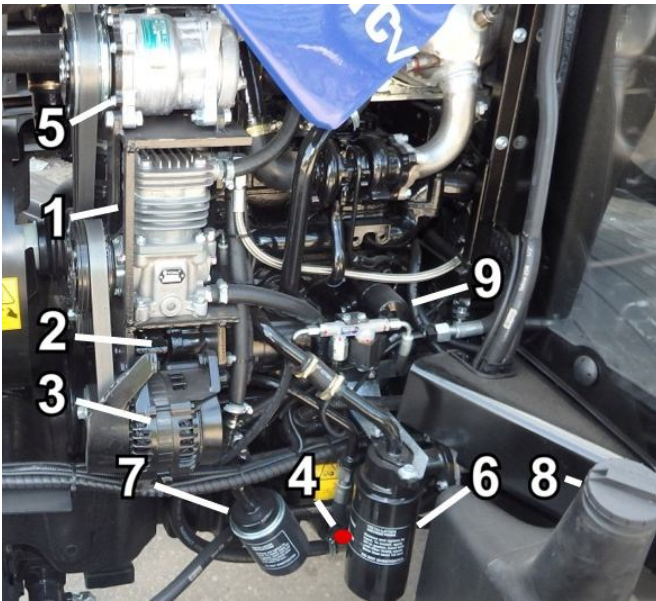

Fig. 5.3.2. Engine L.H. side.

1- Brake system air compressor. 2- Hydraulic pump. 3- Alternator. 4- Engine oil drain plug. 5- A/C Air compressor. 6- Hydraulic oil filter. 7- Engine oil filter. 8- Fuel tank cup. 9- Turbo oil filter.

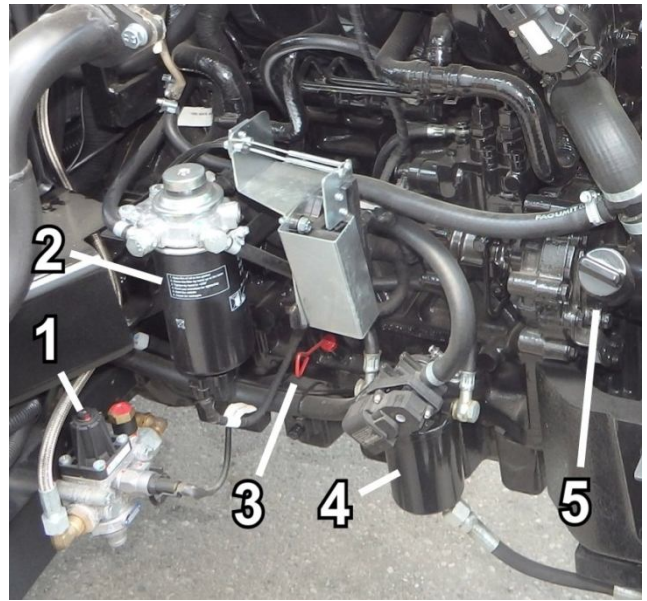

Fig. 5.3.3. Engine R.H. side.

1- Air Pressure regulating valve. 2- Fuel filter. 3- Dipstick. 4- Fuel filter Primary. 5- Engine oil filler

	<p>WARNING: Don't mix different kinds of engine oil.</p>
--	---

5.3.2. Fuel system.

Keep fuel system clean. It is recommended to clean fuel tank once a year. Fill the tank with clean diesel fuel. Don't empty fuel tank completely.

Fuel filter maintenance

Remove water and impurities from the filter every 50 hours of operation (5- Fig. 5.3.4).

To remove water and impurities from the fuel filter, loosen the drain plug (6 - Fig. 5.3.4) at the bottom of the fuel filter to allow the water/fuel to drain into a suitable container. Additionally tractor is fitted with water separator (3- Fig. 5.3.4). Drain the separator when water and impurities accumulates inside by loosening the drain plug (4 - Fig. 5.3.4).

Every 600 hours of operation change the fuel filter element (5-Fig. 5.3.4).

To replace the fuel filter canister:

- thoroughly clean the outside surface of the fuel filter assembly,
- loosen the drain nut at the bottom of the filter and allow the water/fuel to drain into a suitable container,
- use a strap wrench or similar tool to loosen the filter canister and remove the canister,
- lubricate lightly the two top seals 2 and 3 of the new canister with clean fuel. Fit the new canister to the filter head and tighten, by hand only,
- eliminate the air from the fuel filter, see "Bleeding the fuel system" in this section.

Bleeding the fuel system

If air enters the fuel system, it must be removed before the engine can be started.

Air can enter in to the system if:

- the fuel tank is drained during normal operation,
- the low-pressure fuel pipes are disconnected,
- a part of the low-pressure fuel system leaks during engine operation.

If it is required to vent the fuel system, loose Air drain plug (7-Fig. 5.3.4) and operate Fuel hand primary pump (2-Fig. 5.3.4) until fuel is forced out. When fuel free of air bubbles flows out tighten the plug and clean up of fuel.

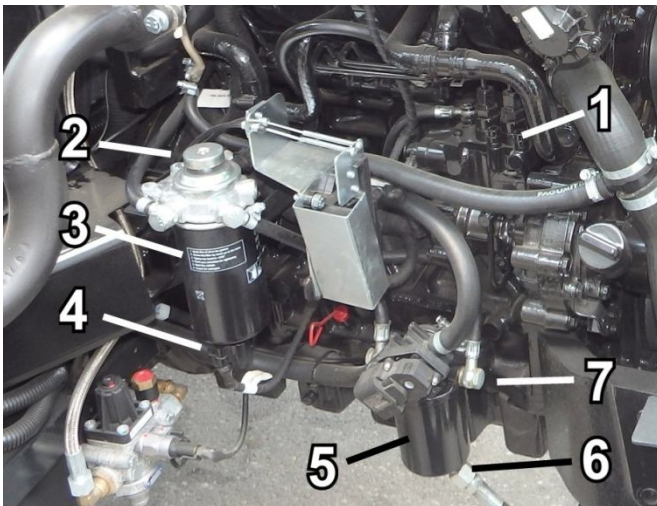

Fig. 5.3.4. Fuel system.
1- Fuel injection pump.
2- Fuel hand primary pump.
3- Water separator.
4- Water separator drain plug.
5- Fuel filter.
6- Fuel filter drain plug.
7- Air drain plug.

5.3.3. Dry air cleaner.

Dry air cleaner maintenance.

Remove any accumulated dust from the dry air cleaner dust collector every 10 hours of operation, or daily in extremely dusty conditions (Fig. 5.3.6);

Clean the outer element every 50 hours of operation, or whenever the air cleaner warning light on the instrument panel comes on..

To clean the outer element:

- Stop engine before air cleaner servicing. Do not operate engine without filter elements.
- Remove the retaining wing nut and carefully slide the element out the filter housing,
- Clean the element by hand. Do not beat the element against a hard surface as the element may be damaged or distorted,
- Alternatively, compressed air not exceeding 2 kg/cm² may be used. Insert the air line nozzle inside the element and blow the dust from the inside to the outside. Keep the nozzle at a safe distance from the element. Blow loose particles from the outside of the element by holding the nozzle at least 150 mm from the element,
- reinstall the outer element ensuring that the rubber sealing ring on the end is secure.

Filter elements replacement:

- Replace primary filter after 3 cleanings or 600 hours of operation.
- Ensure dust ejector valve is in place & intact.
- Safety filter to be replaced at 3rd replacement of primary filter.
- Do not wash the primary filter & safety filter ever.
- Ensure gasket washer is installed correctly before fastening wing nut.

NOTE: Never attempt to clean the inner element. It must be replaced.

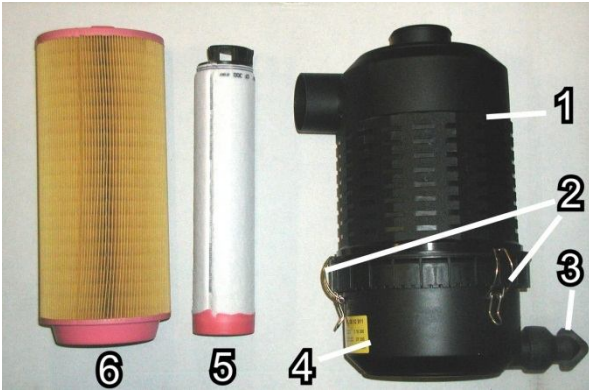

Fig. 5.3.6. Dry air cleaner. 1-Filter housing. 2- Latches. 3- Dust collector . 4- Cover. 5- Inner element. 6- Outer element.



Fig. 5.3.7. Radiator drain tap.

5.3.4. Cooling system.

Check the radiator coolant level every 10 hours of operation, or daily.

With the engine cold, remove the radiator filler cap (1 - Fig. 5.3.8) and check that the coolant level is with the bottom of the filler neck. Top up, as necessary.

Clean the radiator matrix and oil cooler every 10 hours of operation, or daily. by blowing compressed air from the rear of the radiator.

Every year or every 900 hours of operation clean cooling system and change coolant.

In order to drain and refill the cooling system, precede as follows:

- ensure that the tractor is on level ground,
- remove the radiator filler cap (1 - Fig. 5.3.8),
- open the tap (Fig. 5.3.7) at the bottom of the radiator in order to drain the radiator,
- close the drain taps,
- refill the system with a relevant fresh coolant to the correct level,
- operate the engine and then recheck the coolant level and top up as necessary.

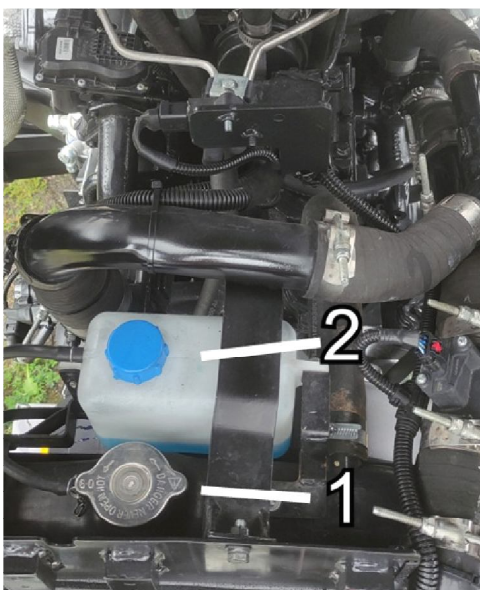

Fig. 5.3.8. Cooling system.

1-radiator filler cap,
2-coolant excess tank.

5.4. Electrical system.

The electrical system is connected to battery after earth switch is switched on (11-Fig. 3.4.).

WARNING:



- To avoid damage to the alternator charging system, observe following service precautions:
- NEVER make or break any of the charging circuit connections, including the battery, when the engine is running.
 - Washing tractor, be careful and don't let water enter into the alternator and starter motor.
 - NEVER short any of the charging components to earth.
 - ALWAYS disconnect the battery earth terminal when installing or removing the alternator.
 - DO NOT use a slave battery of higher than 12 volts nominal voltage.
 - ALWAYS disconnect the battery earth cable when charging the battery in the tractor using a battery charger.
 - ALWAYS observe correct polarity when installing a battery or using a slave battery to jump-start the engine.
 - ALWAYS disconnect the battery earth cable before carrying out arc welding on the tractor or on any implement attached to the tractor.

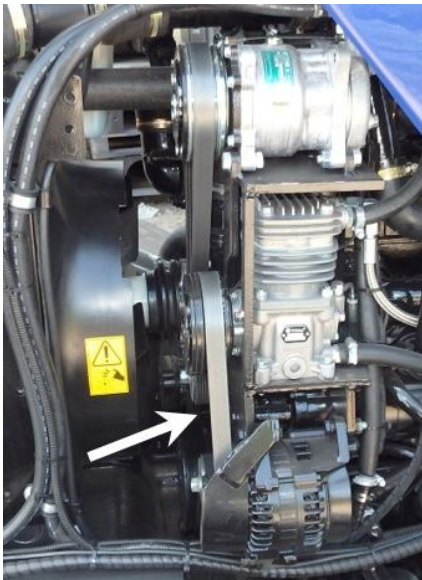

Fig. 5.4.1. Multi-V-belt drive of air compressor, alternator and coolant radiator fan.

5.4.1 Alternator maintenance.

Check the fan/alternator V-belt tension after first 50 and every 300 hours of operation. (Fig. 5.4.1). The correct belt deflection is 8 mm, with the belt depressed (with a force of about 25N).

If adjustment is required:

- loosen the pivot fasteners of the alternator and the adjustment link fasteners,
- change the position of the alternator to give the correct tension. Tighten the pivot fasteners of the alternator and the adjustment link fasteners,
- check the belt tension again to ensure that it is still correct. If a new belt is fitted, the belt tension must be checked again after the first 20 hours of operation.

It is recommended that only an Authorized Dealer carry out the alternator service.

5.4.2. Starter motor maintenance.

Check and clean the starter motor pinion every 600 hours of operation.

To check and clean:

- disconnect the cable from the battery earth terminal, from the starter motor and solenoid,
- extract the three securing bolts and remove the starter motor,
- examine the starter pinion for clutch dust contamination and, if necessary, clean with a solution of 75% paraffin (kerosene) and 25% lubricating oil.

WARNING: Don't start the starter motor when engine is on which may cause the motor damage. Don't crank the engine longer than 5 second and next crank can be made after 30 seconds.



5.4.3. Battery maintenance.

The battery (1- Fig.5.4.2) is mounted on the R.H. side under the cab step. To gain access to the battery, remove the nut (2- Fig. 5.4.2) securing the shelf and deflect the shelf with the battery.

Check the electrolyte level every 50 hours of operation. The electrolyte level in each cell should be 10 ÷ 15 mm above the top of separator plates and can be measured with glass tube. If necessary, replenish each cell with distilled water to the required level.

When conventional battery is fitted, periodic inspection of electrolyte level and concentration is required.

At regular intervals, clean the battery terminals and cable ends, then lubricate them with petroleum jelly. Keep the battery top clean.

To ensure proper battery performance, check also at regular intervals the electrolyte concentration so that the battery charge level could be defined.

If the battery is found discharged to 50 %, or more, it should be recharged until a signs of full battery charge are evident (intensive gas emission) and the electrolyte concentration.

NOTE: In some territories maintenance free batteries are fitted on tractors. Follow the manufacturer's maintenance instructions.

WARNING: 1. During servicing be utmost careful when in contact with sulphuric acid (pour acid into water) to prevent contamination of the body, clothing or other objects. If such contamination occurs, immediately flush the contaminated spot with water liberally and neutralize with 2,5% solution of borax and water. The electrolyte should be prepared using protective clothing and glasses.
2. Do not approach the battery with an open fire and avoid situations leading to short-circuit or "flashing" as explosion is likely to occur.



5.4.4. Spot lights adjustment.

Regarding the safety of road traffic the front headlights adjustment should be executed in authorized service depot.

5.4.5. Bulb and fuse - replacement.

Be sure of correct power of installed bulb. Disconnect the main earth switch before bulb change.

NOTE: Do not replace blown fuse with another of a different capacity

The fuse box is accessible after removing the fuse box cover. (25-Fig. 3.1)..

Fuses location in fuse box is specified in table No. 9 .Table No. 8 describes bulbs specification.

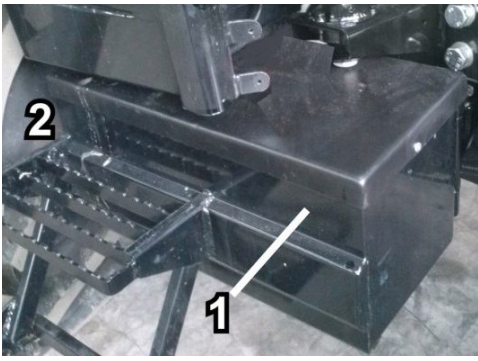

Fig. 5.4.2 Battery.
1- Battery box,
2- Battery box mounting bolt.

Table 8

Application	Bulb indication	Nos. per tractor
Headlights (main beam)	HB3 12V 60W	2
Headlights (dipped beam)	HB3 12V 60W	2
Flashing indicators (front)	12V 21W	2
Front marker lights	12V 5 W	2
Front, rear work lamps	LED 10-30V 27W	4
Rear marker lights	LED 12-24V 1,2/2,4W	2
Stop lights	LED 12-24V 1/2W	
Flashing indicators (rear)	LED 12-24V 1,2/2,4W	
Number plate illumination	12V 5 W	1
Cab lighting	12V C5 W	1

Fuse location in fuse box											
12	11	10	9	8	7	6	5	4	3	2	1
13		14			15			16			

Fig. 5.4.3 Fuse layout in fuse box

Table 9

Fuse No.	Electric circuit	Capacity
1	Headlights (main beam)	15A
2	Headlights (dipped beam)	15A
3	Marker lights	15A
4	Fuel supply control device, A/C	10A
5	Stop lights, Indicator lights	10A
6	12V power supply socket, gauges and warning lamps	10A
7	Front air blower, 7 pin socket	15A
8	Roof switches, roof work lamps	15A
9	Screen, radio player	15A
10	Bonnet work lamps	10A
11	Supply of indicators and switches, combined switch	25A
12	Relays of main and dipped beam	25A
13	Hazard warning lights, cab lighting,	25A
14	A/C compressor	15A
15	-	15A
16	Roof work lamps	15A

5.5. Hydrostatic steering system.

Hydrostatic steering system has an independent oil system with its own oil reservoir with filter (Fig. 5.5.1). Check the hydrostatic steering oil and possibly replenish to above minimum level every 300 hours of operation. Every 600 hours of operation change the hydrostatic steering oil.



Fig. 5.5.1. Hydrostatic steering oil reservoir:
1 - Oil reservoir housing.
2 - Filler plug with oil level dipstick.

5.6. Front axle.

Lubrication

Every 50 hours of operation grease front axle pivot pins (4-Fig. 5.6) grease points.

Check the oil level in the front final drive housing (3-Fig. 5.6) and clean the breather (2-Fig. 5.6) of the final drive housing every 50 hours of operation.

To check, remove the filler / level plug (3-Fig. 5.6). The oil should reach the edge of level hole.

To clean the oil breather, remove it, clean in fuel oil and allow it to dry. Tighten it to a torque of 10 Nm. Change the oil in the front final drive housing every 900 hours of operation.

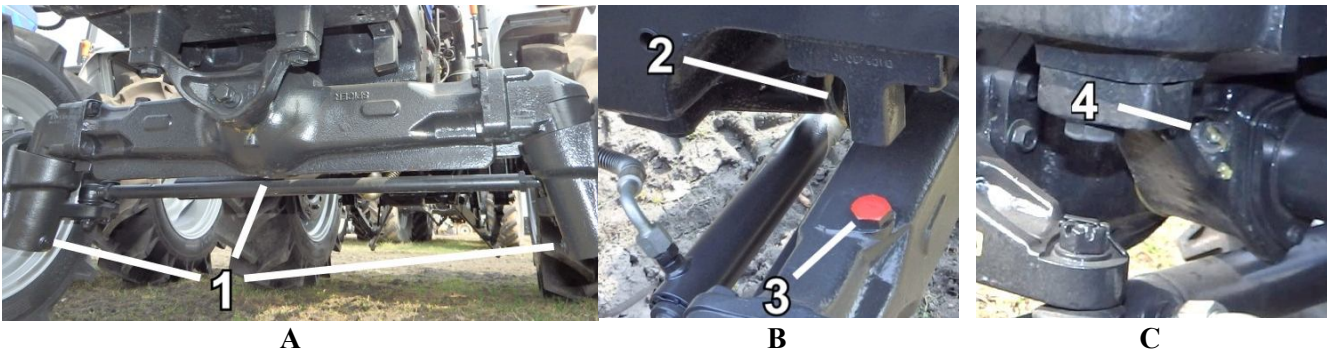



Fig. 5.6. Front drive axle.

1- Oil drain plug, 2- Breather, 3- Filler / level plug, 4- Front axle pivot pin greasing points,

	WARNING: Replace flexible hoses of Hydrostatic Steering System every 5 years or when found any damage.
---	---

5.7. Wheels.

5.7.1. Front wheel track adjustment.

The different track widths are obtained by altering the position of the wheel rim in relation to the reduction unit flange as well as by reversing the wheels and interchanging them in the range of 1200 ÷ 1550 mm.

NOTE: If the wheels are reversed, they must be transferred to the opposite side of the tractor so as to maintain the correct tyre tread direction.

NOTE: After wheel tracks change check the front wheel nuts tightening and adjust front wheel toe-in.

When refitting or adjusting front wheel, tighten the nuts/bolts progressively to the following torque:

- rim to disc – **225 Nm**,
- disc to axle hub – **100-140 Nm**.

5.7.2. Front wheels toe-in.

Toe-in measurement and adjustment .

Check and adjust the front wheel toe-in every 600 hours of operation and after every change in the track setting and when excessive tyre wear is noticed.

To adjust front drive axle toe-in:

- dismount the track rod,
- loosen the lock nut of track rod at each track rod end,
- shorten or lengthen the track rod by track rod ends rotating. Adjustment must be made equally to both track rod ends in within , $A \pm 4 \pm 12$ mm- Fig. 5.7.2,
- refit the track rod to the front axle and tighten the lock nuts, to the torque of 140 Nm,
- recheck the toe-in and adjust, if necessary.

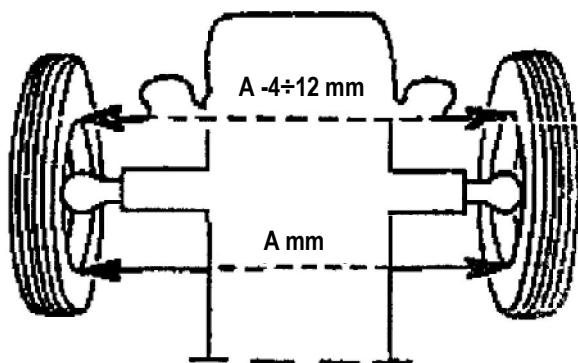
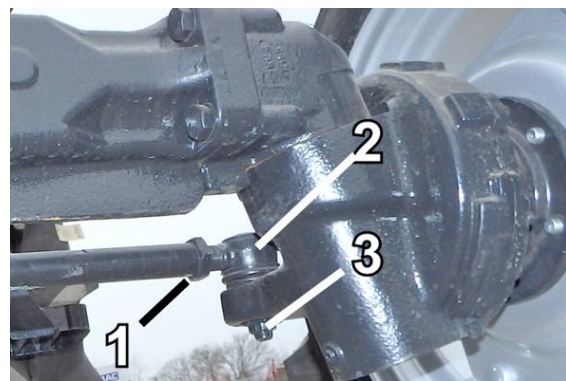

Fig. 5.7.2. Front drive axle toe-in adjustment



1- track rod, 2- track rod end, 3- lock nut.

5.7.3. Rear wheel track adjustment.

Rear wheel track adjustment is effected by changing the position of the wheel rim in relation to the axle hub as well as by reversing the wheels and interchanging them. in the range of 1339 ÷ 1542 mm.

NOTE: If the wheels are reversed, they must be transferred to the opposite sides of the tractor so as to maintain the correct direction of the tyre tread.

When refitting or adjusting a wheel, tighten the nuts/bolts progressively to the following torque:

- rim to disc – **225 Nm**,
- disc to axle hub – **170-190 Nm**.

WARNING: Recheck after driving the tractor 200 m and then twice at 10 hour interval. If heavy work is involved, check twice at 2 hour interval until torque is held according to the values as given above.



5.7.4. Tyres use & maintenance.

Check tyre inflation pressure every 10 hours of operation or daily before starting work.

WARNING: These rules, if followed carefully, will ensure maximum tyre life:



- Apply recommended tyre pressures, check that the tyre pressures are correct for the particular operation to be performed. In certain conditions the pressures may be lowered, particularly where the loads are light or the soil is very humid, resulting in the tyre tread failing to self-clean. If the tyre pressures are reduced, have someone observe the tractor. Do not exceed 20 km/h on the road, if the tyre pressures have been lowered for ploughing.
- Keep oil grease and strong alkaline or acid fertilizers away from the tyres to prevent deterioration of the rubber.
- re-vulcanized any small sidewall, or thread splits or cuts, as soon after they occur as possible. This extends the life of the tyre.
- Tyre inflation pressure at one axle wheels must be equal.

5.8. Clutch.

Every 50 hours of operation grease:

a) with grease,

- reverse pivot sleeves (Fig. 5.8.) – upper sleeve is accessible after opened tractor bonnet and lower sleeve is accessible after removed steering column LHS cover

b) with grease-maintaining agent - clutch linkage attachment pivot in clutch pedal lever fork

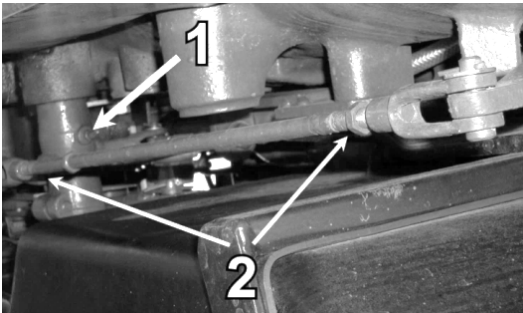

Fig. 5.8. Free travel adjustment of transmission clutch pedal.
1 – Clutch linkage pivot grease point. 2 – Lock nut.

Check and adjust, if necessary, the free travel of transmission clutch pedal every 150 hours of operation.

- loosen the locknut and remove the split pin and clevis pin,
- turn the clevis to lengthen or shorten the operation rod, as required,
- secure the clevis pin with a new split pin and tighten the locknut.

With correct lever setting, clutch pedal free travel is 22÷25 mm.

5.9. Transmission & rear axle maintenance.

Every 50 hours of operation check and replenish if necessary transmission & rear axle oil. When controlling oil level, park tractor on level ground.



Fig. 5.9.1. Rear axle / transmission oil drain plug..

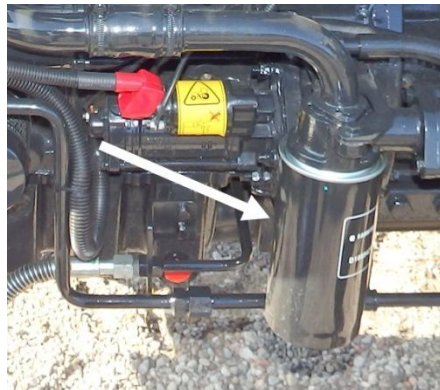

Fig. 5.9.2. Hydraulic oil filter.



Fig. 5.9.3. Transmission oil filler plug

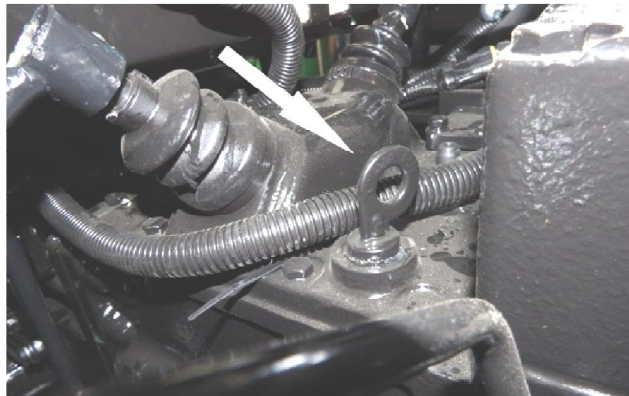

Fig. 5.9.4 . Transmission oil level dipstick.



Replace hydraulic oil filter primary (Fig. 5.9.2) every 300 hours of operation. Transmission & rear axle oil should be replaced every 900 hours of operation or once a year short time after stopping the engine. To drain the oil remove drain plug at the bottom of rear axle (Fig. 5.9.1) and wait for a moment to allow the oil to drain to a suitable container, replace plugs after oil has completely drained. Refill the rear axle with clean oil through the filler plug at rear axle center housing (Fig. 5.9.3). After refilling, oil should reach level between top and bottom mark on the dipstick. Remove the dipstick, (Fig. 5.9.4) wipe it off and then check the oil level again, if necessary top up. The transmission oil level dipstick is located at the top, on the left side of the transmission behind the hydraulic lift (looking from the rear of the tractor).

WARNING: Don't mix different kinds of engine oil.



5.10. Three-point linkage.

Grease every 50 hours of operation, lift rods greasing fittings as shown on Fig. 5.10.
Threading joints grease every 300 hours of operation.



Fig. 5.10. Three-point linkage greasing points

5.11. Cab and operator's seat.

Clean the cab air filter every 50 hours of operation. Clean every 10 hours or daily if operated in heavy dust conditions.

To remove and clean the air filter, proceed as follows (5-Fig. 3.5):

- unscrew two bolts securing the grille to the roof,
- pull the filter out,
- clean the filter element by blowing on the filter element with compressed air at a pressure not exceeding 0,7 MPa and keeping the nozzle at a reasonable distance from the element. The air stream should be directed opposite to this of air flow in normal operation,
- before refitting the filter element, wipe out its compartment with a damp cloth to remove the remaining dust particles,
- refit the filter element correctly to ensure proper air flow and tightness,
- refit the filter guard.

Do not direct the water jet onto the cab air filter, when washing the tractor.

Grease elements of operator's seat suspension; every 300 hours of operation.

5.12. Braking system.

5.12.1. Service brake adjustment.

Check the brakes operation every day.

Pedal correct free travel should be 20 - 25 mm.

If the free travel is out of the limits, as given above, or the braking performance of wheels is uneven, adjust the brakes by screwing the brake pump push rod fork in or out.

To adjust the brakes, proceed as follows :

- chock the front wheels,
- release the parking brake,
- unlatch the brake pedals,
- remove the instrument panel cover,
- unlock the locknut
- adjust by turning push rod in brake pump fork so that there is a free travel at the pedal of 22 to 25 mm,
- lock the locknut),
- repeat the procedure for the other side brake,
- if the adjustment range does not permit obtaining correct adjustment, adjust the length of operating rods of the system,

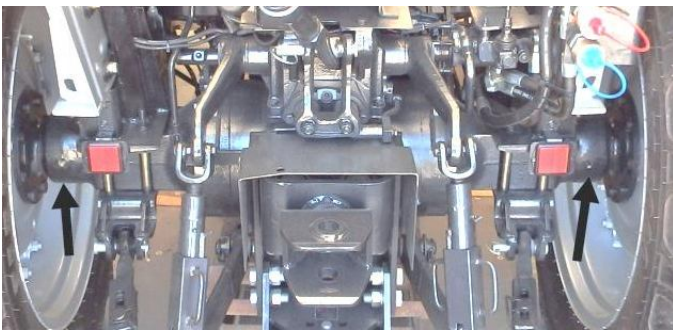

Fig. 5.12.1. Three-point linkage greasing points

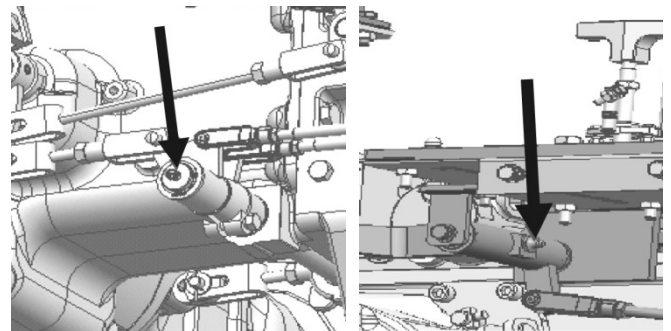

Fig. 5.12.2. Parking brake lever pivot grease fitting

5.12.2. Parking brake.

Parking brake adjustment should follow the service brake adjustment.

If correctly adjusted, the parking brake should act securely, when the ratchet pawl is snapped in the third to fifth recess on the rack, counting from the lowest position.

Adjust the parking brake as follows:

- latch the brake pedals,
- place the parking brake lever in its lowest position,
- slacken the pull rod locknut, each side,
- shorten the pull rods by turning the adjusting nuts as far as possible and without interfering the free travel of the brake pedals,
- retighten the lock nuts,
- check the brake for correct adjustment. After engaging the parking brake, the air pressure at the air coupler should drop to atmospheric pressure,
- road test the tractor with the brakes latched and check the parking brake for pulling to one side.

Lock the brake pedals together and road test to ensure that the brakes are balanced and will stop the tractor in a straight line. If the tractor pulls to one side, adjust until the brakes are correctly balanced.

5.13. Air braking system.

Tractor air braking system is used for actuating the trailer air brakes and for tyre inflating. Tractor system is adapted to control trailer with single or double-line trailer air braking system. It is fitted with trailer control valve. The system contains of Air compressor, Pressure regulating valve, Air reservoir, coupling for connection to trailer air braking system (Fig. 5.14.). Air braking system is shown at Fig. 5.13.

	1. Never start towing of a trailer with the air pressure gauge showing pressure below $0,4 \pm 0,04$ MPa.
	2. Stop towing of a trailer with air braking system if the air pressure warning light illuminates.

Air compressor

The energy (compressed air) source for trailer air braking system is a piston one cylinder compressor Ø65 mm bore and 76 cm³ displacement operate on 800 to 3000 rpm and obtain a capacity of max 85 l/min.

The air compressor is equipped with a special type of valves enabling the pressure to be self-stabilized. This means that the pressure in the air reservoir is maintained constant due to the compressor delivery stopping at a definite pressure.

The compressor maintains a pressure ranging between 1.1 and 1.4 MPa in the system, from the compressor to the pressure regulating valve.

The air compressor is driven by V-belt from the engine crankshaft pulley, operating on 800 to 3000 rpm and obtain a capacity of max 85 l/min.

The compressor is pressure lubricated with the engine oil from the engine lubrication system.

The lamp on instrument panel (12-Fig. 3.2) illuminates when air pressure inside the trailer air braking system falls below $0,4 \pm 0,04$ MPa and the pressure gauge (10-Fig. 3.3.2) informs about the current pressure in the air container.

Avoid to contact the V-belt to oil and grease.

Check the fan/alternator V-belt tension after first 50 and every 300 hours of operation. (Fig. 5.4.1).

The correct belt deflection is 8 mm, with the belt depressed (with a force of about 25N).

If adjustment is required:

- loosen the pivot fasteners of the alternator and the adjustment link fasteners,
- change the position of the alternator to give the correct tension. Tighten the pivot fasteners of the alternator and the adjustment link fasteners,
- check the belt tension again to ensure that it is still correct. If a new belt is fitted, the belt tension must be checked again after the first 20 hours of operation.

It is recommended that only an Authorized Dealer carry out the alternator service.

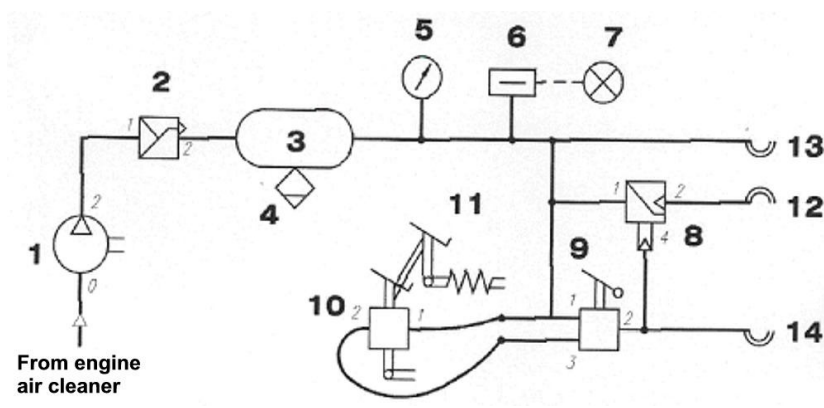

Fig. 5.13. Diagram of air system. 1 - Air compressor. 2 - Pressure regulating valve. 3 - Air reservoir. 4 - Drain valve. 5 - Air pressure gauge. 6 - Air pressure sensor. 7 - Air pressure drop warning light. 8 - Trailer braking valve. 9 - Parking brake valve. 10 - Trailer braking control valve. 11 - Equalizing valve. 12 - Coupling valve. 13 - Coupling valve red. 14 - Coupling valve yellow .

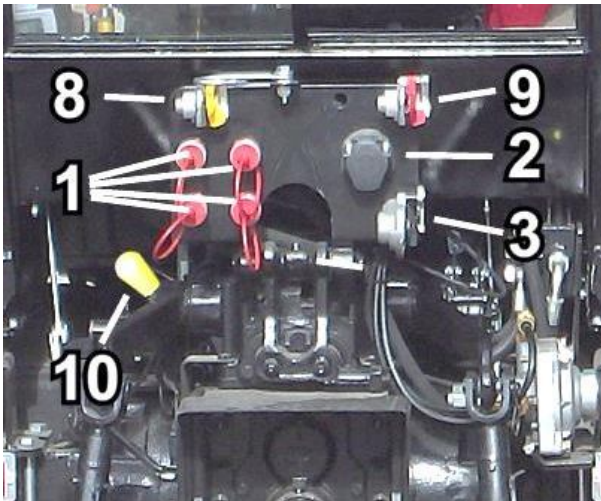

Fig. 5.14. Rear of the tractor

1- Quick couplers (see description in 4.5.2). 2- Seven pin socket. 3- Coupler of single line trailer air braking system. 5- Hydraulic lift rocker. 8- Supply socket air braking system. 9- Control socket air braking system. 10- PTO 540/540E selector lever.

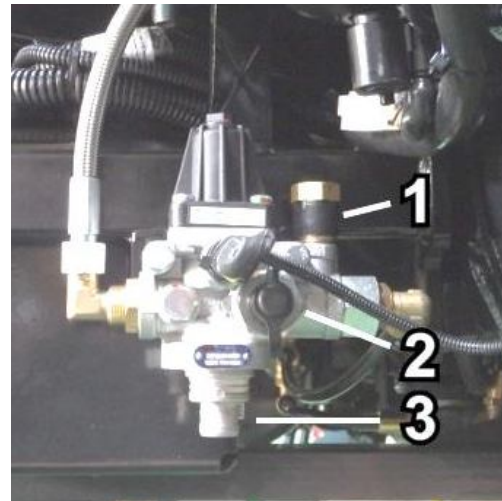

Fig. 5.15. Air Pressure regulating valve.

1- Safety valve.
2- Tyre inflating valve.
3- Air regulating valve.

Air reservoir

The capacity of the air reservoir is 15 liters. The air reservoir ensures the compressed air supply to the trailer air braking system. It prevents rapid pressure drop in the system when the trailer air brakes are used frequently.

After 900 hours of operation or after two years of operation, and then every 900 hours or once a year clean the reservoir thoroughly with detergents and blow through with hot air.

At every tractor inspection ensure that the air compressor is firmly secured.

A defective reservoir (cracks, indents, etc.) should be replaced by a new one immediately.

Any kind of the air reservoir repair is not permitted

Drain water from the air reservoir every 10 hours of operation or daily by pushing drain valve at bottom of the reservoir.

Pressure regulating valve with safety valve

The pressure is compressed to the air container through the valve. The valve reduces the air pressure maintained by the compressor to $p_e=0,8^{±0,02}$ and $Δp_e=0,06^{±0,0,4}$ MPa. The pressure regulating valve is fitted with a tyre inflating valve and a safety valve which limits the maximum air pressure inside the tractor pneumatic installation for braking the trailers (Fig. 5.15).

To inflate the tractor or trailer tyres, first reduce pressure in air system to 0,3 MPa (stop the engine and drop air by the drain valve from the air reservoir) and connect the valve to the wheel inflation valve with a rubber hose and with the engine running, inflate tyres to the prescribed pressure. The valve is located on front lower edge of cab on tractor R.H. side (beside main earth switch).

No periodical servicing of this pressure regulating valve is necessary. Inspections and adjustments can be made by a specialized service only.

Equalizing device

The equalizing device (which is at the same time the foot of R.H. side brake pedal) is used for leveling the R.H. and L.H. pedal plates of the main brake (two pedals latched together).

Neither servicing nor adjustment of this device is necessary.

Trailer braking control valve

The foot brake valve (which is at the same time the foot of R.H. side pedal) is used to operate the trailer brakes.

The trailer braking force is proportional to the pressure exerted on the brake pedal. Pressing on the pedal causes the compressed air supply to the trailer to be progressively cut off and thus braking the trailer. The air escapes through the valve.

Adjust the foot brake valve every 250 hours of operation by setting correct length of the valve linkages.

The adjustment of the foot brake valve must always follow the adjustment of tractor brakes.

Parking brake valve

The valve is connected by pull rod with the parking brake lever. When engaging the parking brake, the hand brake valve is operated (a hissing sound of the air escaping from the valve should be heard). If the hand brake valve is out of operation (no hissing sound) shorten the pull rod which connects the valve with the parking brake lever.

Coupling valve

The pneumatic system of the tractor and trailer can be coupled by means of this valve which is standard design.

Connecting the trailer and tractor air braking system

The tractor is fitted with three couplings (3, 8, 9 - Fig. 5.14):

white – to couple single line trailer air braking system,

red – to supply triple line trailer air braking system,

yellow – to control triple line trailer air braking system.

All couplings are fitted with automatic valves to cut off tractor air braking system after disconnected of trailer coupling. The couplings are accordant to ISO standard.

To couple the trailer and tractor air braking system, equalize air pressure in tractor system with ambient pressure (by engaging the parking brake) and after connecting hose couplers release the parking brake. Tractor and trailer braking should be at the same time. Couple also trailer electrical system to the tractor seven pin socket (2 - Fig. 5.14).

5.14. Hydraulic lift.

Hydraulic lift is supplied with oil from tractor transmission system.

Grease lift rocker solid grease.

Bleeding Hydraulic lift system:

- check transmission system oil level before bleeding, replenish if required,
- start the engine, move slowly distributor lever from “raising” to “lowering” position – without loading three point linkage,
- don't load hydraulic lift with implements for several minutes.

6. TRACTOR STORAGE

If your tractor is to be out of service of any length of time, certain precautionary measures must be taken to safeguard it.

It is recommended, if the standstill period is not very long, to run the engine every 7 days until the operating temperature of the engine is reached (green scale in the water temperature gauge).

If the tractor is to be out of service for an extended period of time the following precautionary measures should be taken:

- clean the tractor,
- drain the engine and transmission oil and refill with fresh oil,
- drain the fuel tank and pour approximately 10 litres of special calibrating fuel into the tank. Run the engine for at least 10 minutes to ensure complete distribution of the calibration fuel throughout injection system. See the next item before running the engine,
- check the radiator coolant level. If the coolant is within 200 hours of the next change, renew the coolant. Run the engine for one hour to disperse the inhibitor throughout the cooling system,
- lubricate all grease fittings,
- rise the lift linkage hydraulically and support the lift arms in the fully raised position,
- lightly coat all exposed hydraulic piston rods with petroleum jelly, e.g. power steering cylinder rams, spool valves, etc.,
- remove the battery and store in a warm, dry atmosphere. Recharge periodically,
- raise the tractor and place supports under the axles to take the weight off the tires,
- block the clutch pedal in the fully depressed position,
- cover the exhaust pipes opening

PREPARING THE TRACTOR FOR USE AFTER STORAGE

- inflate the tires to the correct pressure,
- refill the fuel tank,
- check the radiator coolant level,
- check all oil levels,
- install a fully charged battery,
- remove the exhaust pipe covering,
- start the engine and check that all instruments and controls are functioning correctly,
- drive the tractor without a load to ensure that it is operating satisfactorily